

Dominion Energy Southeast Services, Inc.
400 Otarre Parkway
Cayce, SC 29033



September 18, 2020

Mr. Greg Cassidy
State Voluntary Cleanup Program
Bureau of Land and Waste Management
South Carolina Department of Health and Environmental Control
2600 Bull Street
Columbia, SC 29201

**Re: Congaree River Project
Attachment C – Project Description
Columbia, South Carolina**

Dear Mr. Cassidy:

In support of the Dominion Energy South Carolina (DESC) Congaree River Project, the following Attachment C – Project Description will be included in the United States Army Corps of Engineers (USACE) permit application that will be submitted by September 30, 2020.

The attached Project Description provides supplemental information for the Joint Application that includes a narrative that provides essential details regarding development and implementation of the Stakeholder-Developed Modified Removal Action (MRA). SCDHEC correspondence related to the stakeholder developed MRA is provided in Appendix A. Other appendices to the Project Description, include various implementation support plans that consist of:

- Cofferdam Inspection and Maintenance Plan;
- Site Operations Plan;
- Water Management Plan; and
- Total Suspended Solids Monitoring Plan.

The Department's written approval/concurrence of the attached Project Description and other support plans is an important component of the permit application submittal to the United States Army Corps of Engineers.

If you have any questions regarding this submittal, please contact Paul Biery of DESC at 803-217-5016.

Sincerely,

A handwritten signature in blue ink that reads "T. N. Effinger".

Thomas N. Effinger, P.E.
Director, Environmental Services

Enclosures

cc: P. Biery – DESC
R. Contrael – ACE
W. Zeli – Apex



**JOINT APPLICATION SUPPLEMENT
PROJECT DESCRIPTION**

**CONGAREE RIVER STAKEHOLDER-DEVELOPED MODIFIED REMOVAL ACTION
COLUMBIA, SOUTH CAROLINA**

September 2020

Prepared for:

Dominion Energy South Carolina, Inc.
400 Otarre Parkway
Cayce, South Carolina 29033

Prepared by:

Apex Companies, LLC
1600 Commerce Circle
Trafford, Pennsylvania 15085

TABLE OF CONTENTS

1.0	INTRODUCTION	1
2.0	DESCRIPTION OF OVERALL PROJECT.....	1
3.0	IMPLEMENTATION CONSIDERATIONS	2
3.1	Project Area Access	3
3.2	Cofferdams.....	3
3.3	Site Operations Plan.....	5
3.4	Water Management	5
3.5	Excavation and Material Management	6
3.6	UXO and Historical Artifacts Support Plans.....	7
4.0	SITE RESTORATION	8
5.0	MITIGATION MEASURES	10
5.1	Navigation (GC 1).....	11
5.2	Aquatic Life Movements, Spawning Areas and Endangered Species (GCs 2, 3 and 18).....	11
5.3	Historical Properties (GC 20)	13
6.0	CONSTRUCTION SCHEDULE	15
7.0	COMPLIANCE CERTIFICATION STATEMENT.....	16

TABLES

- 1 Estimated Removal Volumes
- 2 Summary of Federal and State Rare Threatened and Endangered Species

FIGURES

- 1 Site Location Map
- 2 Comparison of Removal Areas
- 3 TLM Distribution and Approximate Thickness
- 4 TLM Thickness and Volume Comparison
- 5 Conceptual Site Operations Plan

APPENDICES

- A SCDHEC Correspondence
- B Cofferdam Inspection and Maintenance Plan
- C Site Operations Plan
- D Water Management Plan
- E Total Suspended Solids Monitoring Plan

1.0 INTRODUCTION

This Project Description has been prepared on behalf of Dominion Energy South Carolina, Inc. (DESC) to provide supplemental information for the Joint Federal and State Application Form (Joint Application) for the planned Modified Removal Action (MRA) for tar-like material (TLM) and impacted sediments within a portion of the Congaree River in Columbia, South Carolina.

The general site location and planned removal areas are shown on Figure 1. The project area includes the proposed removal areas and landside area necessary for access and operations to support the removal activities. As summarized in the Joint Application Form (item 33), the purpose of the MRA is to remove TLM and impacted sediments from the project area and eliminate its potential for human contact. The MRA will also mitigate the potential for resuspension and downstream movement of impacted sediments.

The MRA is being planned at the direction of the South Carolina Department of Health and Environmental Control (SCDHEC). A plan for the removal of tar-like material within the Congaree River was requested by SCDHEC in a letter dated July 31, 2018 (see Appendix A). The documentation in Appendix A is being provided as required by Nationwide Permit (NWP) Regional General Condition 47a.

In response to the July 2018 SCDHEC letter, a Preliminary Removal Action Work Plan (PRAWP) was prepared and submitted to SCDHEC on September 12, 2018. In a letter dated October 22, 2018 (see Appendix A), SCDHEC acknowledged receipt of the PRAWP and proposal to remove tar-like material from the Congaree River, and directed DESC to proceed with the process of obtaining permit approval from the US Army Corps of Engineers (USACE).

To facilitate the planning process and assure concurrence with the scope of the planned removal efforts, DESC participated in a meeting with Stakeholders on November 15, 2018. As follow-up to that meeting, DESC prepared the Conceptual Plan for a Modified Removal Action – December 2018 (Stakeholder-Developed MRA Plan) described in Section 2.0. The Stakeholder-Developed MRA Plan was submitted to SCDHEC on December 12, 2018 for confirmation of Stakeholders agreement. In a letter dated February 7, 2019 (see Appendix A), SCDHEC provided their agreement with the plan along with Declarations of Support from two primary stakeholders, Congaree Riverkeeper and Guignard Associates LLC.

There has been a considerable amount of work undertaken in support of this project, which is available in the Administrative Record and can be found on SCDHEC's website at the following location: <http://www.scdhec.gov/HomeAndEnvironment/Pollution/CleanUpPrograms/OngoingProjectsUpdates/CongareeRiverSediment/AdministrativeRecord/>. The Administrative Record is also available for review at the main branch of the Richland County Public Library located at 1431 Assembly Street, Columbia, SC 29201.

2.0 DESCRIPTION OF OVERALL PROJECT

The Stakeholder-Developed MRA Plan delineates a revised approach toward completing a "Modified" Removal Action to address impacted sediment that exists within a portion of the Congaree River in

Columbia, SC. The project objective is to pursue a MRA that consists of the removal of TLM and impacted sediment from two separate areas as depicted on Figure 2 as a revised approach that may be able to receive a favorable USACE permit decision for the necessary cofferdam as well as all other required regulatory approvals. The project description in this section is being provided for general information purposes and as a supplement to item 32 in the Joint Application Form.

The MRA will involve removal of impacted sediments from areas that are:

- Close to the shoreline and therefore more susceptible to human dermal contact or exposure (e.g., river users such as kayakers, waders/swimmers, fishermen etc.); and
- More concentrated with tar-like-material (TLM), or where thicker deposits of TLM are shown to exist.

Figure 2 shows the outline of the previously proposed full-scale removal area versus the currently proposed two areas comprising the MRA. The volumes shown on Figure 1 for each approach were calculated using a combination of new survey information collected in the spring of 2018 and the sediment coring logs collected from the remedial investigations conducted in 2010 to 2012. Figure 3 shows the proposed MRA areas with a GIS visualization of each sediment boring as a TLM “hot-spot” which depicts the greater thickness of the TLM by a brighter color. Figure 4 provides an updated depiction of the average TLM thickness with estimated volume, using a similar GIS tool in which the data representation extends into the adjacent data point. Sediments in the “other areas” that will not be removed consist of either:

- Relatively minor thicknesses of TLM, and/or
- Are now covered by additional sediment resulting from the “superstorm” of 2015; and/or
- Occur far enough away from the shoreline and in deeper water, whereby risk of human dermal contact or exposure is minimal.

The currently proposed MRA consists of two areas as shown on Figures 2 through 4. Area 1 is approximately 2.6 acres and as proposed, has a similar footprint to the original full-scale Phase 1 Area. Area 2 is approximately 0.5 acres in size. Table 1 provides a comparison of volume estimates from previously submitted documents. Assuming successful completion of the MRA, an estimated 73 percent of the total TLM will have been removed from the Congaree River.

3.0 IMPLEMENTATION CONSIDERATIONS

The primary implementation considerations involve the following items discussed in this section:

- Access to the project area;
- Cofferdam placement within the river for isolation of the removal areas;
- Site operations plan for the landside support zone;
- Dewatering and water management for the removal areas inside the cofferdams;

- TLM and sediment excavation, management, transport and disposal; and
- Support plans for screening and management of unexploded ordnance (UXO) and historical artifacts.

3.1 Project Area Access

DESC evaluated several options for access to the project area, including access from the north along the river using City of Columbia-owned property (northern access), from Senate and Gist Streets (central access), and from Blossom Street (southern access).

Landside access to the project area within the river is currently anticipated from Senate and Gist Streets using the central access option. A lease agreement with the property owner is anticipated to allow for both access to the river and the landside operations that will be necessary to support MRA activities within the river. Site access and the anticipated lease area are identified on the conceptual site operations plan provided as Figure 5.

3.2 Cofferdams

To isolate the removal areas and allow for dewatering and screening the areas for the potential presence of UXO and historical artifacts, reinforced rockfill berm cofferdams will be installed. The cofferdam locations around Areas 1 and 2 are identified on Figure 3. The design of the cofferdams is presented with the set of drawings provided as Attachment B to the Joint Application.

Design and Construction Considerations

Features of the design include:

- A spillway height of 123.5 feet (NGVD 29), designed to minimize overtopping events during the primary construction season;
- Full reinforcement of the outboard side of the cofferdam to minimize damage and risk of material loss;
- Full reinforcement of the overtopping structure to minimize damage to the cofferdam during overtopping events;
- A level surface at the top of the cofferdam, of sufficient width and finish to provide a driving surface for project support vehicles;
- Placement of a HDPE liner within the fill to reduce leakage and associated water handling requirements; and
- A HDPE pipe (or equivalent) through the downriver end of the cofferdam with a check valve, to allow for dewatering of the interior area following an overtopping event.

Prior to initiating cofferdam construction, the footprint of each cofferdam will be addressed following the Mussel Relocation Plan described in Section 5.0 and UXO Management Plans described in Section 3.6. Detailed plans for cofferdam construction will be developed by the construction/remediation contractor. Each area will be addressed separately using the following general construction considerations:

- Total suspended solids (TSS) monitoring will be conducted in accordance with the TSS Monitoring Plan provided in Appendix E during cofferdam construction to monitor and control potential sediment release from the work area;
- The river bank surface that interfaces with the cofferdam will be stripped and prepared properly during installation;
- Material will generally be placed in lifts as the cofferdam is constructed;
- The outlet structure will be installed as material lifts are being placed;
- HDPE liner and reinforcement material (articulated concrete block (ACB) mats) will be placed over the outboard slope and crest of the cofferdam, with additional reinforcement on the inboard slope at the spillways and other critical sections (based on anticipated sediment removal depth);
- Diversion berms, sumps and pumps will be utilized for dewatering the inboard area;
- To the extent practicable during initial dewatering, fish present within the cofferdam area will be captured and relocated within the river, and the presence of vulnerable or imperiled plant species (Rocky Shoal's Spider Lily) will be assessed and these plants will be relocated to a suitable habitat.
- Removal of TLM and sediment within the isolated area, to the extent feasible;
- Pressure wash the exposed bedrock bottom of the river where necessary;
- Deconstruction (i.e., removal of the reinforcement and other cofferdam materials from within the river following completion of sediment removal within each area); and
- The cofferdam in each area will be constructed following the same general sequence.

Real-Time Water Quality Monitoring

Downstream and upstream (background) real-time TSS monitoring will be conducted during cofferdam construction activities to ensure the project does not contribute to elevated TSS levels within the river. Conducting real-time TSS monitoring downstream of the construction area and comparing the results to the background levels from upstream, if needed, will provide timely notification of elevated project related TSS conditions, should they occur. Mitigation measures, such as deployment of a silt curtain, will be employed if an increase above the established conservative TSS action level is indicated. Specific details with respect to the TSS monitoring, action level and the mitigation procedures are provided in the TSS Monitoring Plan located in Appendix E.

Inspection and Maintenance

The Cofferdam Inspection and Maintenance Plan (Appendix B) provides a detailed daily cofferdam structure inspection plan that will be implemented by project oversight personnel. Areas of inspection include the cofferdam structural integrity, exterior conditions (such as debris buildup), riverbank tie-in locations, overall performance and leakage volumes, navigational signage and notification components, expected future river levels, etc. An inspection form will be completed during each work day and any potential areas in need of repairs will be documented and addressed as soon as practical. Implementation of this plan will ensure that cofferdam structural issues are identified and rectified in a timely manner and that project personnel are aware of changing river conditions and can plan accordingly.

3.3 Site Operations Plan

The Site Operations Plan (Appendix C) is intended to provide general procedures to safely and effectively implement the proposed MRA activities. Several site preparation activities will take place prior to initiating the removal work to assure the safe and effective implementation of the MRA. The conceptual approach to the site operations plan is summarized on Figure 5. Some variations to the plan may occur, depending on site conditions encountered at the time of remediation. The actual layout for site operations will be finalized at the discretion of remediation personnel provided DESC, SCDHEC and the landside property owner concur with any significant modifications.

Site preparation and operations will involve the following activities addressed in the plan:

- Landside support zone construction;
- Utility clearance and management;
- Archaeologist demarcation of historic and archaeological sites;
- Evaluation of the power line corridor and demarcation of plant species of concern locations, if present;
- Site office location;
- Site security and fencing;
- Stormwater management and sedimentation controls;
- Work zones;
- Traffic control; and
- Staging areas.

3.4 Water Management

Management of water will be a major component of the overall remediation project. The Water Management Plan (Appendix D) provides details on the anticipated procedures to be implemented during remediation activities. For implementation purposes, water to be managed has been divided into two categories: non-contact water and contact water.

Non-contact water is visually unimpacted water that has not been in contact with TLM or impacted sediments. It includes water from initial dewatering or overtopping events, cofferdam leakage, landside stormwater run-on, and non-contact removal area water including precipitation falling within the cofferdams. Contact water is water that has been in contact with TLM or impacted sediments or appears to be visually impacted (e.g., contains large amounts of suspended solids, exhibits a sheen, or has TLM particles suspended within the water column). The area of origin of the water will be a primary consideration in determining which mode of water management will be used, along with a visual evaluation by site personnel.

The on-site water management system will be used to contain, filter and discharge contact water. The planned discharge location is a sanitary sewer manhole located near the eastern perimeter of the landside support zone shown on Figure 5. Stormwater from the landside operations area will be

controlled via the requirements and best management practices (BMPs) established in the Comprehensive Stormwater Pollution Prevention Plan (C-SWPPP) submitted with the Notice of Intent (NOI) for coverage under the South Carolina National Pollutant Discharge Elimination System (NPDES) General Permit for Stormwater Discharges from Construction Activities. Non-contact water within the removal areas, including leakage through the cofferdam, will be contained and returned to the river as described further in the Water Management Plan.

3.5 Excavation and Material Management

The major objective of this project is the removal of the TLM and impacted sediment from within the removal areas to the extent practicable. However, visually un-impacted sediment will also be removed and conservatively managed similar to “impacted sediment”. After the cofferdam in each area is constructed, initial dewatering operations will begin and the water from within the cofferdam will be systematically lowered. At this point coordination of several activities will be required including:

- Conduct mussel relocation activities, if not conducted in conjunction with the cofferdam footprint;
- Safely screen the removal area for potential UXO as described in the UXO Management Plans;
- Complete final dewatering of the removal area; and
- Construct an internal, bermed area along the toe of the cofferdam for the leakage/seepage water collection system.

There will be two types of advance screening of the work areas, including mussel relocation activities and UXO clearance and management. No intrusive removal operations will be conducted unless the planned removal area has been screened and designated as safe by the UXO management personnel. UXO screening and management will be conducted in accordance with the UXO Management Plans further discussed in Section 3.6. The UXO personnel will clear portions or the entire isolated and dewatered area prior to permitting the initiation of removal operations. The mussel relocation activities are further discussed in Section 5.0.

After final dewatering and construction of the leakage/seepage water collection system, the removal area will be relatively water-free and suitable for safe removal of the sediment. A combination of removal methodologies and equipment will most likely be required to successfully complete the project due to the varying thickness of sediment and changing bathymetric conditions within the project area. Standard excavation methods coupled with vacuum removal or other techniques will likely be employed.

It is currently estimated that approximately 11,700 cubic yards (CY) of sediment material (or 23,350 tons using a 2.0 conversion factor) are present within the proposed removal areas. Table 1 provides a summary of the material estimates. These volume estimates are approximations due to the inherent difficulties with measuring sediment thicknesses and the variations of the river bottom within the project area. Additionally, the majority of material to be removed from the river will likely require addition of a drying agent or other bulking agent to render the material suitable for transportation to the on-site screening facility or the off-site disposal facility. Therefore, the actual final tonnage will depend on a number of variables.

Sediment material removed from the river will be screened for historical artifacts on-site by trained professionals operating under direct supervision of the project archaeologist. Methods and procedures to be used have been developed and reviewed by SCIAA. A Memorandum of Agreement (MOA) between DESC, USACE and SCIAA was signed in May 2017 and will be updated as necessary. If required, more highly impacted material may be transported directly to a prepared site at the disposal landfill for artifact screening. Recovered artifacts will be preserved in accordance with SCIAA-approved procedures.

As envisioned, sediment removal will start from the northern portion of each cofferdam and progress southward. However, the removal area sequence is subject to change based on conditions including the river bottom characteristics, sediment volume and thickness, and presence of TLM, as well as the judgement of the remediation contractor. Sediment removal within the cofferdam will be further controlled via the establishment of grids, or controlled sequences, to minimize the area of open excavation, to document progress and conditions, and for artifact recovery purposes. To the extent practicable, sediment removal operations will extend inward toward the riverbank until visual impacts are no longer present.

To the extent practicable, the excavated sediment will be piled or stacked in designated draining areas where entrained water will be allowed to flow away from excessively wet material. This water will be contained and ultimately transferred to the water management system. This technique will reduce the amount of material conditioning required to transport the impacted sediment to the next location or step in the process. Any contact water collected on the landside will also be transferred to the water management system.

After allowed to drain, the sediment will be mixed with a conditioning or drying agent (e.g., saw dust) or commercially available polymer, as necessary, to render it suitable for transport to the landside support zone for further conditioning and artifact screening. After the artifact screening process, DESC will utilize appropriately licensed transportation companies to conduct the material transportation activities to the landfill. Similar to material disposal during remediation of the Huger Street former MGP site, use of the Waste Management Richland County Landfill is currently anticipated for disposal of the excavated material. All shipments will be manifested in accordance with federal and state requirements.

3.6 UXO and Historical Artifacts Support Plans

Due to the potential presence of UXO and historical artifacts in the removal areas, support plans have been developed to address these items. The plans have been provided as attachments to the Joint Application in response to application or permit condition requirements and are summarized below.

UXO Screening and Management

UXO screening and management will be conducted in accordance with the UXO Management Plans (Attachment N to the Joint Application), which provide specific details pertaining to the UXO management operations. No intrusive construction or removal operations will be conducted unless the work area has been screened and designated as safe by the UXO management personnel. As currently planned, the UXO management personnel will conduct diving operations to clear the path of the cofferdam footprint prior to the initiation of cofferdam construction. The area within the cofferdam will be cleared in sections or its entirety after the area has been adequately dewatered.

DESC previously retained Explosive Ordnance Technologies, Inc. (EOTI) to address the planning phase for screening, removal and management of the UXOs. EOTI developed the following four UXO Management Plan documents, consistent with typical USACE guidance and protocols:

- Draft Work Plan for Munitions Response MEC Clearance and Support;
- Explosive Safety Submission Munitions and Explosives of Concern Clearance and Support;
- Dive Safe Practices Manual; and
- Diving Operations Plan.

These four plans, provided in Attachment N to the Joint Application, will be updated, as necessary. During implementation of the MRA, each identified metal anomaly will be evaluated and confirmed as either UXO, historical artifact or other metallic debris and managed in accordance with the approved plans.

Historical Artifacts Screening and Recovery

This project involves the potential presence of historical artifacts located within the river. Therefore, DESC has worked closely with the South Carolina Institute of Archaeology and Anthropology (SCIAA) and the State Historical Preservation Office (SHPO) to develop an appropriate approach to recover and preserve any potential historical properties.

The Cultural Resource Identification Survey and Archaeological Data Recovery Plan developed by TRC Environmental Corporation are provided in Appendix M. The recovery plan contains the specific methodology and techniques that are currently planned for processing the removed material and segregating the potential artifacts. Recovered artifacts will be preserved in accordance with SCIAA-approved procedures. A draft Memorandum of Agreement (MOA) between USACE, DESC and SHPO/SCIAA is also provided in Appendix M.

4.0 SITE RESTORATION

Minimizing disturbance and properly restoring disturbed areas will be a critical component of the overall project. Figure 5 provides the currently anticipated site operations plan scenario and indicates the potential approximate areas of activity for landside operations, removal operations within the river, and locations along the eastern shoreline of the riverbank that will likely be disturbed as a result of MRA activities. Efforts will be undertaken to safeguard the remainder of the areas from impacts. Areas where disturbance may not be necessary will be demarcated with flagging or fencing to ensure they are not impacted by removal operations or heavy equipment movement unless required. This preservation technique will be a key to minimizing the disturbed areas.

In areas where landside operations occur and shoreline impacts are unavoidable, DESC will conduct restoration activities. DESC plans to strategically locate landside site operations components in areas that will limit the need for clearing and grading activities, as much as practical. This scenario will reduce disturbance of currently forested land and further preserve the riparian corridor. It will also minimize the amount of landside restoration activities that will be required prior to final demobilization. Restoration

plans are described in two documents provided as attachments to the Joint Application in response to application or permit condition requirements (Attachment K – Draft Stormwater Management and Sediment Control Plan and Attachment P – Restoration Operation, Maintenance and Monitoring Plan). Restoration of the landside operations area, removal areas within the river, and the disturbed riverbank and shoreline locations are described briefly below.

Landside Restoration

Prior to mobilization, a Notice of Intent will be submitted to the City of Columbia for coverage under South Carolina NPDES General Permit For Stormwater Discharges From Construction Activities SC100000. This submittal will include a Comprehensive Stormwater Pollution Prevention Plan which includes a Stormwater Management and Sediment Control Plan (SMSCP). The SMSCP provides details on erosion and sediment control methods to be established, maintained and inspected at the site during active operations, as well as plans for final restoration following completion of landside activities. The general approach to final restoration of the landside operations areas is to restore the locations to pre-MRA conditions to the extent practical.

River Restoration

DESC plans on removing all sediment and gravel, small rocks, etc. (both visually impacted with TLM and visually unimpacted material) from the removal areas to the extent practical. Large rocks that are visually unimpacted may be temporarily relocated within the work area to facilitate sediment removal and then returned to their approximate original locations. As an additional measure, DESC plans to pressure wash the exposed bedrock bottom of the river where necessary. Water generated during the pressure washing stage will be collected and removed from the excavation for treatment and discharge to the City of Columbia Public Owned Treatment Works (POTW). The intent is to remove any residual staining or impacts due to the presence of TLM.

Current plans do not include replacing any removed material with backfill. The TLM, impacted sediment, and visually un-impacted sediment will be removed down to the top of the underlying bedrock. In many areas, this will only require removal of several inches of sediment. Following completion of the removal activities, the cofferdam will be removed and over time, the natural depositional processes of the river will restore the river bottom to natural conditions. This process will allow for natural re-deposition of sediment within the removal area based on current river hydraulics. Not replacing the impacted sediment with fill material will also eliminate the potential for backfill materials to be washed downstream and deposited in other areas or degrade other habitats through siltation, etc.

Riverbank and Shoreline Restoration

Detailed plans for the riverbank and shoreline restoration are provided in Attachment P to the Joint Application (Restoration Operation, Maintenance and Monitoring Plan). It is estimated that approximately 975 linear feet of the project area shoreline may be impacted by MRA activities. Shoreline disturbances will be limited to the extent practical. These locations include access roads and cofferdam/riverbank tie-in locations. Available delineation data suggest that TLM is not located within the riverbank soil and as a result, much of the riverbank and riparian corridor may be left undisturbed.

Restoration will include recreating the approximate shoreline slope, stabilization of the bank via riprap and/or bioengineered solutions, and restoration of vegetative cover where practical. DESC's goals are to minimize riverbank disturbance where possible, to restore disturbed areas to natural pre-MRA conditions,

and to utilize bioengineering techniques and structures to the extent practical when repairing impacted shoreline. As stated above, portions of the riparian corridor where disturbance may not be necessary will be demarcated to ensure that they are not impacted unless required. This preservation technique will be a key component of the overall project.

Following completion of the MRA sediment removal and restoration activities, the riverbank and shoreline area will be monitored to assure restoration was successful. Periodic inspections will occur on a monthly basis or following significant weather-related events for a period of one year, unless property owner redevelopment plans result in an earlier change to restored conditions. Should issues be identified during inspections that warrant mitigation, DESC will implement repairs to the affected area(s), as necessary, to assure sufficient stabilization.

As project plans are further developed, certain details or specifications regarding restoration may be modified in order to reflect minor changes or input from applicable experts and/or the property owner. The USACE, SCDHEC and other agencies, as may be appropriate, will be made aware of any major modifications to planned activities prior to implementation.

5.0 MITIGATION MEASURES

Measures to mitigate potential impacts during implementation of the MRA are described in this section. The measures are based on anticipated requirements of the permit authorization as determined from review of the Joint Application, NWP General Conditions (GC) and Regional General Conditions (RGC). This information supplements Items 39 and 40 of the Joint Application and addresses factors identified in GC 23. The mitigation measures described below include plans to address:

- Navigation within the river during MRA implementation (based on GC 1);
- Aquatic life, spawning areas and endangered species within the project area (based on GCs 2,3 and 18); and
- Historic properties within the project areas (based on GC 20).

Additional measures to avoid impacts associated with MRA implementation are described in plans developed to address other requirements of the Joint Application. These measures address landside, riverbank and shoreline, and within the river project areas, and include:

- Draft Stormwater Management and Sediment Control Plan for the landside area (Attachment K to the Joint Application);
- Restoration Operation, Maintenance and Monitoring Plan which addresses the riverbank and shoreline, including the area below the ordinary high-water mark (Attachment P to the Joint Application); and
- Total Suspended Solids Monitoring Plan which describes monitoring and contingency measures for TSS within the river (Section 3.2 and Appendix E in this Project Description).

Compensatory mitigation is not required because no wetlands are adversely impacted and the MRA project has an overall positive environmental impact. The proposed removal action within the river portion of the project area is short-term and the improvement resulting from removal of the TLM-impacted sediment will be permanent. Removing the impacted sediment will provide benefit in the form of reduced potential for contact with the TLM by humans and other organisms. Removal of the TLM also reduces the potential for resuspension and downstream movement and reduction in the potential for flux of dissolved phase constituents with the water column. Aquatic resource function and quality will be improved due to the removal of the impacted sediment. The cofferdams and other support operations will be removed and disturbed portions of the riparian corridor will be restored following completion of the MRA. No permanent loss of wetlands, open waters, riparian areas or aquatic habitat will occur.

5.1 Navigation (GC 1)

The Draft Navigation Plan (Attachment G to the Joint Application) was developed in accordance with the instructions provided with the United States Coast Guard (USCG) Private Aids to Navigation Application. The Application and Draft Navigation Plan will be finalized and submitted to the USCG for approval following receipt of permit authorization for the USACE.

The Plan provides specific methods for notifying boaters and other users of the river in advance of the project location (upriver and downriver) and the need to take appropriate measures to avoid the cofferdam structure. It provides the specific methods for demarcating the area to be avoided and the buoy/signage/lighting scenario for the project. Implementation of the MRA will have no adverse impact on navigation in the Congaree River.

5.2 Aquatic Life Movements, Spawning Areas and Endangered Species (GCs 2, 3 and 18)

Aquatic Life Movements

Because the project area will only occupy a portion of the river at any given time and downstream and upstream movement and access of aquatic organisms will not be impeded, no impact on aquatic life movements is anticipated.

Spawning Areas

Downstream movement of suspended particles and sediment liberated from the work area can potentially impact spawning areas and other aquatic resources. BMPs such as roadway construction and maintenance, shoreline stabilization and deployment of sediment (i.e., silt) curtains, etc. will be utilized as needed. Erosion and sediment control measures associated with the landside support zone are presented in the Draft Stormwater Management and Sediment Control Plan (Attachment K to the Joint Application).

As described in Section 3.2, downstream and upstream (background) real-time TSS monitoring will be conducted during cofferdam construction activities to ensure the project does not contribute to elevated TSS levels within the river. Specific details with respect to the TSS monitoring, action level and the mitigation procedures are provided in the TSS Monitoring Plan located in Appendix E. Conducting real-time TSS monitoring downstream of the construction area and comparing the results to the background levels from upstream, if needed, will provide timely notification of elevated project related TSS conditions,

should they occur. Mitigation measures, such as deployment of a silt curtain, will be employed if an increase above the established conservative TSS action level is indicated.

Endangered Species

The project area was evaluated for the potential presence of threatened and endangered species and spawning habitat. Due to the nature of the project and the associated mitigation measures built into the project plans, specifically the project construction schedule (Section 6.0) and the freshwater mussel relocation activities described in this section, project related activities are not anticipated to negatively impact sensitive species or spawning areas/migrations. A number of sources were used to assess the potential presence of endangered or threatened species in the project area and include:

- U.S. Fish and Wildlife Service (FWS);
- U.S. National Marine Fisheries Service (NMFS);
- South Carolina Department of Natural Resources (SCDNR); and
- The Rare, Threatened and Endangered Species Assessment developed by Kleinschmidt (March, 2008) prepared for the Saluda Hydroelectric Relicensing Project (FERC project no. 516).

Table 2 provides a summary of Federal and State Rare, Threatened and Endangered Species for the project area general vicinity. The Kleinschmidt report was primarily focused on Lake Murray and the Lower Saluda River and the downriver extent was generally terminated at the confluence with the Broad River or the headwaters of the Congaree River (Figure 1). However, the shortnose sturgeon study and the freshwater mussels study conducted as part of the assessment activities extended into the upper Congaree River including the planned project area. Review of these assessments and the available information from the FWS and SCDNR identified a number of federal and state threatened and endangered species, federal candidate species and other species of concern.

Of specific interest to this general project area are the Rafinesque's big-eared bat, shortnose sturgeon, robust redhorse sucker, species of freshwater mussels, and three plant species (Georgia aster, smooth coneflower and Rocky Shoal's Spider Lily). The Rafinesque's big-eared bat and shortnose sturgeon are listed as state endangered species and state and federal endangered species, respectively. The robust redhorse sucker is identified as critically imperiled on the federal list. Eight species of freshwater mussels listed in Table 2 are potentially present in the project area and range from "vulnerable" to "imperiled" at either the national or state level in the NatureServe database. The smooth coneflower is a federal endangered species, the Georgia aster is a federal candidate species, and the Rocky Shoal's Spider Lily is a federal vulnerable and NatureServe imperiled species.

The Rafinesque's big-eared bat's range includes the sandhills region and it is known to roost under I-beam and T-beam bridges. The Gervais Street Bridge may provide a roosting site for this bat. However, project activities will occur downstream of the bridge and should not impact potential roosting sites within the structure.

The shortnose sturgeon have been anecdotally reported to be present in the vicinity of the project area during spawning runs. Based on available information and prior communications with USACE trustees (NMFS and USFWS), if the project is completed between the months of May through October it will not impact potential sturgeon migration. The robust redhorse sucker has been stocked in large numbers in

the Broad River and may be periodically present in the vicinity of the project area. The relatively limited extent of project operations within the river will not be detrimental to this species, if present. Also, during initial dewatering of the areas within the cofferdams, any fish present within the cofferdam areas will be captured and relocated within the river to the extent practicable.

DESC has agreed to conduct freshwater mussel screening and relocation operations in an attempt to preserve indigenous freshwater mussels that may be present within the project footprint. As seen in Table 2, a number of sensitive mussel species were identified in the planned project vicinity. The anticipated mussel relocation activities are explained in detail in the Mussel Relocation Plan (Attachment H). Mussels located within the removal areas, including the planned footprint of the cofferdam structures, will be collected and relocated. As currently envisioned, one of two potential scenarios will be implemented based on project logistical considerations. The first scenario includes conducting the mussel collection and relocation in one mobilization per construction phase following determination of a suitable relocation site. Relocation area(s) will be chosen by the subject matter experts and will be located close to the planned project area. A combination of wading and diving will be necessary in order to adequately survey the majority of the project area. The second scenario includes mobilizing the collection and relocation team and removing the mussels from the approximate footprint of the planned cofferdam and the outboard buffer zone. The relocation team would then demobilize until the cofferdam is constructed and the isolated area is partially dewatered. The team would remobilize and complete the collection and relocation of the mussels within the isolated area. With this scenario, the partial dewatering will facilitate access to the mussels and potentially increase the effectiveness and overall efficiency of the process.

The potential habitat for the smooth coneflower and Georgia Aster would be along the power line corridor located directly east of the river-based project area. Current plans include the use of portions of the power line corridor for landside support activities. During site operations setup activities, the corridor will be evaluated for the presence of smooth coneflower and Georgia Aster. If identified, their location will be demarcated and avoided to the extent practicable during implementation of the project. Should disturbance of these locations become necessary, these plants will be protected or relocated to the extent practical.

The Rocky Shoal's Spider Lily is a perennial plant that inhabits rocky shoals or bedrock outcrops in large streams or rivers at or above the fall line (Kleinschmidt, 2008). It is found in relatively large numbers directly upstream of the project area at the confluence of the Saluda and Broad Rivers, and some portions of the project area may exhibit favorable conditions for its occurrence. Because of the potential for Rocky Shoal's Spider Lily to exist within the removal areas within the river, DESC plans to assess their presence during cofferdam installation and initial dewatering activities. If present, these plants will be relocated to a suitable habitat to the extent practicable.

5.3 Historical Properties (GC 20)

Historic and archaeological properties in the general project vicinity have been identified and specific activities will be undertaken as needed to safeguard these properties during project implementation. A Cultural Resources Identification Survey (CRIS) was conducted by TRC (Attachment M to the Joint Application) that covered the overall project area and general vicinity. In addition, potential historical sites were researched using ArchSite, which is a geographic information system (GIS) maintained by SHPO

and SCIAA. A historic and archaeological properties identification, including tabular listing and figure showing locations, is provided as Attachment L to the Joint Application.

Two separate sites are located in the general vicinity of the project area that are designated as historically significant. The sites consist of the Gervais Street Bridge and the Columbia Canal. Both properties are listed in the National Register of Historic Places. The Gervais Street Bridge is located directly upstream of the project area. Implementation of the project is not expected to adversely impact the Gervais Street Bridge. Although MRA activities are located within the Columbia Canal area as defined by the National Register, project related activities are not expected to adversely impact this historic property.

Nine archaeological sites have been identified in the vicinity of the project area. The locations of these sites are shown on the figure in Attachment L to the Joint Application and include:

- Late 19th to Early 20th Century Artifact Scatter/Dump Site (ID# 38RD233)
- Underwater Civil War Era Ordnance Dumpsite (ID# 38RD286)
- Possible Ruins of Briggs' Saw Mill (ID# 38RD224)
- Late 19th to Early 20th Century Structure Foundation – House (ID# 38RD234)
- Underwater Deposit of Historic Ceramics and Metal Artifacts (ID# 38RD278)
- 19th to 20th Century Bottle Dump/Landfill (ID# 38RD223)
- Expanded Boundary of Underwater Civil War Era Ordnance Dumpsite (ID# 38RD286)
- Unknown Prehistoric Lithic Flake and Brick Fragment Scatter, 20th Century (ID# 38RD275)
- V-Shaped Wooden Object Eroding Out of Riverbank (ID# 38RD235)

One of these sites (ID# 38RD233) is located north of the Gervais Street Bridge and is not expected to be within the disturbed project area. Two of these sites (ID# 38RD275 and ID# 38RD235) are located south of Area 2 and the tributary near the downstream end of Area 2 and are also not expected to be within the disturbed project area.

The originally identified underwater Civil War era ordnance dumpsite area (ID# 38RD286) is just north of the northern end of Area 1 and is not expected to be disturbed. [It should be noted however, that the limits of the Civil War ordnance dumpsite were expanded based on the findings of initial magnetometer studies conducted as part of this project. Area 1 and Area 2 are situated within the ordnance dumpsite (ID# 38RD286).] A 19th to 20th century bottle dump/landfill (ID# 38RD223) is located on the eastern bank of the river between Area 1 and Area 2 and may be partially disturbed although intrusive activities are not expected. Possible ruins from a saw mill (ID# 38RD224) and a former structure foundation (ID# 38RD234) are located directly adjacent to Area 1. The archaeologist will locate these sites in the field, and they will be sufficiently demarcated and avoided to the extent practicable during implementation of the project. Should disturbance of these areas become necessary, proper precautions will be undertaken similar to the plans developed for the protection of other locations of historical significance.

An underwater deposit of historic items (ID# 38RD278) is located adjacent to and within Area 1, and the expanded boundary of the underwater Civil War era dumpsite (ID# 38RD286) is located within the river, including the cofferdam and removal areas. These areas will be impacted by cofferdam construction and

sediment removal activities and are of primary concern. The presence of the Civil War dumpsite presents two primary issues or concerns, including the potential for the artifacts to be UXO and the need to properly recover and preserve any historical artifacts encountered. DESC, SCDHEC and the USACE have invested considerable time and effort into addressing these issues. Multiple UXO management plans have been developed to specify the potential management of such items. The current plans are provided as Attachment N to the Joint Application and will be updated as necessary prior to implementation.

The Field Demonstration Project (FDP) was conducted in the fall of 2015 to evaluate metallic anomalies, and potentially identify historical items or UXO in the alluvial fan area and none were found. Fifty-one previously identified metallic anomaly locations were investigated and only cultural debris and trash was uncovered. As a result, it is expected that a minimal amount of historically significant items and/or UXO is still present within the project area. However, as a precaution, an archaeologist will be on-site to properly document and secure any potential historical items. The Archaeological Data Recovery Plan developed by TRC Environmental Corporation is provided as Attachment M to the Joint Application. It contains the specific methodology and techniques that are currently planned for processing the removed material and segregating the potential artifacts. Recovered artifacts will be preserved in accordance with SCIAA-approved procedures.

An archaeologist will be on-site during intrusive activities to screen material and disturbed areas for historical artifacts after the areas have been prescreened for UXOs as described in the UXO Management Plans. If required, more highly impacted material may be transported directly to a prepared site at the disposal landfill for artifact screening. If historical items are identified, the archaeologist will document the finding and secure the item for transmittal to SCIAA/SHPO in accordance with the Archaeological Data Recovery Plan. The required licenses (Intensive Survey License and Data Recovery License) were previously obtained and will be updated as necessary prior to implementation.

6.0 CONSTRUCTION SCHEDULE

A detailed schedule of activities will be developed following receipt of the required permit approval from USACE and approval of the Final MRA Work Plan by SCDHEC. Key components of the schedule include:

- Obtaining other required permits and approvals, including access;
- Contractor selection; and
- Implementation of the removal action.

Due to seasonal fluctuations in typical river levels, the active in-the-river construction season for building or relocating the cofferdams will be from May through October of each year (pending approval). This construction season also avoids impacts on aquatic life migration and spawning seasons within the river.

The cofferdam construction and sediment removal work will require several seasons to complete. DESC has also requested permission to work behind the cofferdam year-round, with minimal site activity

projected during the months of December through April. Conceptually, the UXO screening may be able to be completed during the off-season, assuming favorable weather/river conditions. The total duration of the project will be contingent upon factors including:

- Detailed plans of the selected contractor, developed in conjunction with DESC;
- Weather and river level conditions;
- The extent of UXO, historical artifact, and cultural debris presence within the project area; and
- Volume of water to be managed.

General considerations regarding the overall schedule for implementation of the MRA include:

- SCDHEC approval – Prepare a Final MRA Work Plan, submit to SCDHEC for review including public and stakeholder comments, and receive authorization.
- Access agreement(s) – Obtain agreement(s) with property owner(s) for landside operations and access to the proposed removal areas.
- City of Columbia approvals – Develop and submit applications to the City of Columbia and receive the required authorizations.
- Remediation Contractor procurement and site operations setup – Prepare project specifications, obtain and review contractor bids, select contractor, and complete site operations setup including access roads.
- Sediment removal with restoration and documentation – Removal of the impacted sediment within Areas 1 and 2, including construction and removal of the cofferdams, is expected to occur over three seasons.

7.0 COMPLIANCE CERTIFICATION STATEMENT

Pursuant to requirements of NWP General Condition 30, following completion of MRA activities, DESC will provide a signed certification documenting completion of the authorized activities and implementation of any required compensatory mitigation.

The certification document is expected to be provided by USACE with the NWP verification letter and to include the following items:

- A statement that the authorized activities were done in accordance with the NWP authorization, including any general, regional or activity-specific conditions;
- If applicable, a statement that the implementation of any required compensatory mitigation was completed in accordance with the permit conditions; and
- The signature of the permittee certifying completion of the activities, and mitigation if applicable.

TABLES

Table 1 Estimated Removal Volumes

Estimated by	MTR	Glenn & Associates	Apex	Percent Removal
	EE/CA Sediment Volume Estimate January 2013 Original, Full-Area Removal	Preliminary Removal Action Work Plan (PRAWP) September 2018 Full-Area Removal	Proposed Conceptual Plan - MRA Sediment Volume Estimate December 2018 MRA Areas 1 & 2	MRA vs PRAWP
Total Volume of Sediment to be Removed	26,700 CY	25,550 CY	11,675 CY	46%
Total Volume of TLM to be Removed	Not Estimated	5,745 CY	4,204 CY	73%

TABLE 2

SUMMARY OF RARE, THREATENED AND ENDANGERED SPECIES FOR THE PROJECT AREA AND VICINITY

Congaree River Sediments
Columbia, South Carolina

Common Name	Scientific Name	Federal Listed and Status ⁽²⁾	State Protection and Status ⁽³⁾	Potential Occurrence
Mammals				
Rafinesque's Big-Eared Bat	<i>Corynorhinus Rafinesquii</i> / <i>Plecotus Rafinesquii</i>	No	Yes - Endangered	Potential for occurrence in project vicinity under the Gervais and Blossom Street bridges.
American Alligator	<i>Alligator mississippiensis</i>	Yes - Threatened	Yes - Threatened	No - habitat not suitable
Birds				
Red-Cockaded Woodpecker	<i>Picoides Borealis</i>	Yes - Endangered	Yes - Endangered	No - habitat not suitable.
Wood stork	<i>Mycteria Americana</i>	Yes - Threatened	Yes - Endangered	No - habitat not suitable, extremely rare and if present likely from dispersion or migration.
Bald Eagle	<i>Haliaeetus Leucocephalus</i>	No	Yes - Threatened	Noted upstream of the project area but not in vicinity of project area. No anticipated impact.
Fish/Amphibians/Reptiles				
Pine Barrens Treefrog	<i>Hyla Andersonii</i>	No	Yes - Threatened	No - found in the sandhills region located northeast of the project area.
Shortnose Sturgeon	<i>Acipenser Brevirostrum</i>	Yes - Endangered	Yes - Endangered	Yes - though if present numbers likely limited
Robust Redhorse Sucker	<i>Moxostoma Robustum</i>	N1 - Critically Imperiled	SNR - Not Ranked	Yes - stocked by SCDNR below Parr Shoals dam.
Southern Hognose Snake	<i>Heterodon Simus</i>	No	Yes - Threatened	No - habitat not suitable
Freshwater Mussels				
Carolina Heelsplitter	<i>Lasmigona Decorata</i>	Yes - Endangered	Yes - Endangered	No - found in rivers and tributaries other than the Congaree River.
Roanoke Slabshell	<i>Elliptio Roanokensis</i>	N3 - Vulnerable	S2 - Imperiled	Yes - potential for occurrence in project vicinity
Yellow Lampmussel	<i>Lampsilis Cariosa</i>	N3N4 - Vulnerable, Apparently Secure	S2 - Imperiled	Yes - potential for occurrence in project vicinity
Carolina Slabshell	<i>Elliptio Congaraea</i>	N3 - Vulnerable	S3 - Vulnerable	Yes - potential for occurrence in project vicinity
Carolina Lance	<i>Elliptio Angustata</i>	N4 - Apparently Secure	S3 - Vulnerable	Yes - potential for occurrence in project vicinity
Fatmucket	<i>Lampsilis Splendida</i>	N3 - Vulnerable	S2 - Imperiled	Yes - potential for occurrence in project vicinity
Eastern Floater	<i>Pyganodon cataracta</i>	N5 - Secure	SNR - Not Ranked	Yes - potential for occurrence in project vicinity
Creeper	<i>Strophitus undulatus</i>	N5 - Secure	S2 - Imperiled	Yes - potential for occurrence in project vicinity
Eastern Creekshell	<i>Villosa delumbis</i>	N4 - Apparently Secure	S4 - Apparently Secure	Yes - potential for occurrence in project vicinity
Plants				
Canby's Dropwort	<i>Oxypolis Canbyi</i>	Yes - Endangered	S2 - Imperiled	No - habitat not suitable
Georgia Aster	<i>Symphyotrichum Georgianum</i>	Yes - Candidate	SNR - Not Ranked	Yes - power line corridor provides potential habitat.
Rough-Leaved Loosestrife	<i>Lysimachia Asperulaefolia</i>	Yes - Endangered	S1 - Critically Impaired	No - habitat is not suitable.
Rocky Shoal's Spider Lily	<i>Hymenocallis coronaria</i>	G3 - Vulnerable	S2 - Imperiled	Yes - known to occur directly upriver of project area.
Michaux's Sumac	<i>Rhus michauxii</i>	Yes - Endangered	SX - Presumed Extinct	No - habitat is not suitable.
Smooth Coneflower	<i>Echinacea Laevigata</i>	Yes - Endangered	S3 - Vulnerable	Yes - power line corridor provides potential habitat.

Notes:

- (1) Freshwater mussel occurrence taken from Kleinschmidt, March 2008.
- (2) If species was not listed in the USFWS Endangered Species Database the NaturServe Global or National Status is shown.
- (3) If species was not listed in the SCDNR SC Rare, Threatened & Endangered Species Inventory the NatureServe State or Subnational Status is shown.
- (4) Federal and state listed threatened and endangered mammals, birds, fish, amphibians, reptiles and plants are provided in table. Mussels with a NatureServe rank are also listed due to their potential presence in the project area.

FIGURES

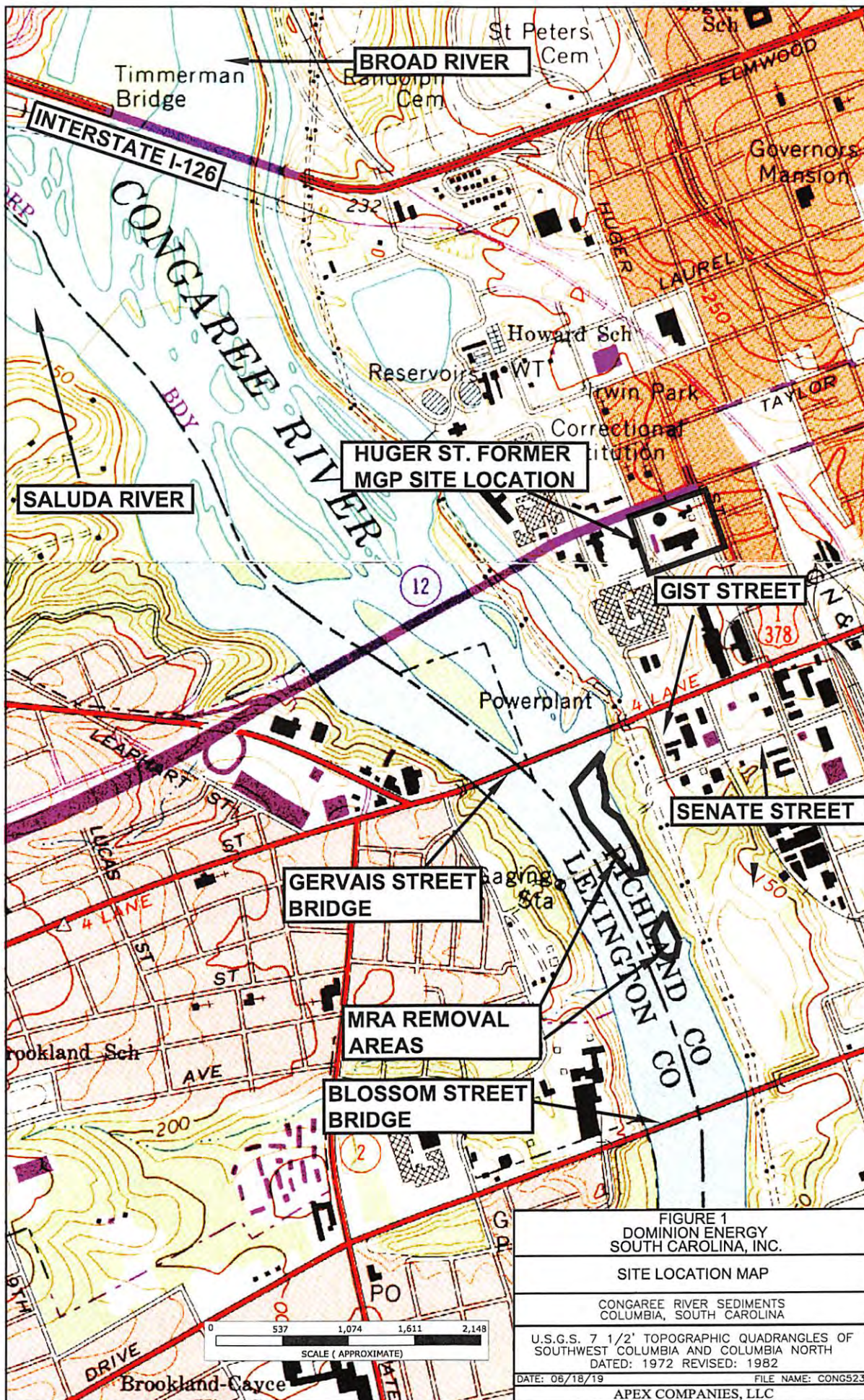

FIGURE 1
DOMINION ENERGY
SOUTH CAROLINA, INC.

SITE LOCATION MAP

CONGAREE RIVER SEDIMENTS
COLUMBIA, SOUTH CAROLINA

U.S.G.S. 7 1/2' TOPOGRAPHIC QUADRANGLES OF
SOUTHWEST COLUMBIA AND COLUMBIA NORTH
DATED: 1972 REVISED: 1982

DATE: 06/18/19

FILE NAME: CONGS23

APEX COMPANIES, LLC

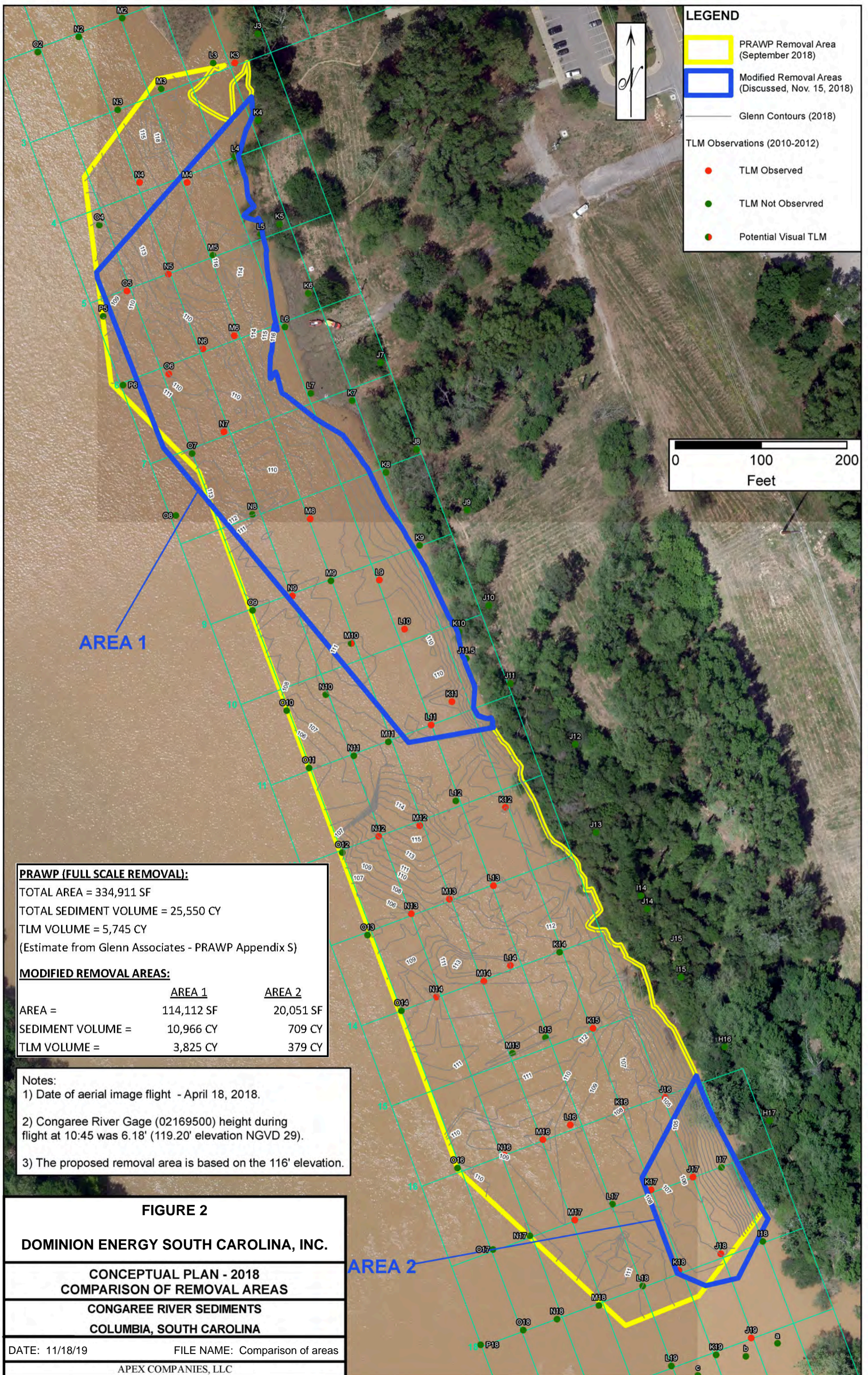

LEGEND

- PRAWP Removal Area (September 2018)
- Modified Removal Areas (Discussed, Nov. 15, 2018)
- Glenn Contours (2018)
- TLM Observed
- TLM Not Observed
- Potential Visual TLM

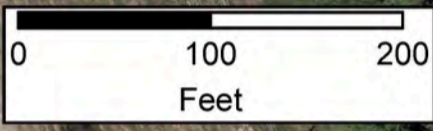

PRAWP (FULL SCALE REMOVAL):
 TOTAL AREA = 334,911 SF
 TOTAL SEDIMENT VOLUME = 25,550 CY
 TLM VOLUME = 5,745 CY
 (Estimate from Glenn Associates - PRAWP Appendix S)

MODIFIED REMOVAL AREAS:

	AREA 1	AREA 2
AREA =	114,112 SF	20,051 SF
SEDIMENT VOLUME =	10,966 CY	709 CY
TLM VOLUME =	3,825 CY	379 CY

- Notes:**
- 1) Date of aerial image flight - April 18, 2018.
 - 2) Congaree River Gage (02169500) height during flight at 10:45 was 6.18' (119.20' elevation NGVD 29).
 - 3) The proposed removal area is based on the 116' elevation.

FIGURE 2

DOMINION ENERGY SOUTH CAROLINA, INC.

CONCEPTUAL PLAN - 2018
COMPARISON OF REMOVAL AREAS
CONGAREE RIVER SEDIMENTS
COLUMBIA, SOUTH CAROLINA

DATE: 11/18/19 FILE NAME: Comparison of areas

APEX COMPANIES, LLC

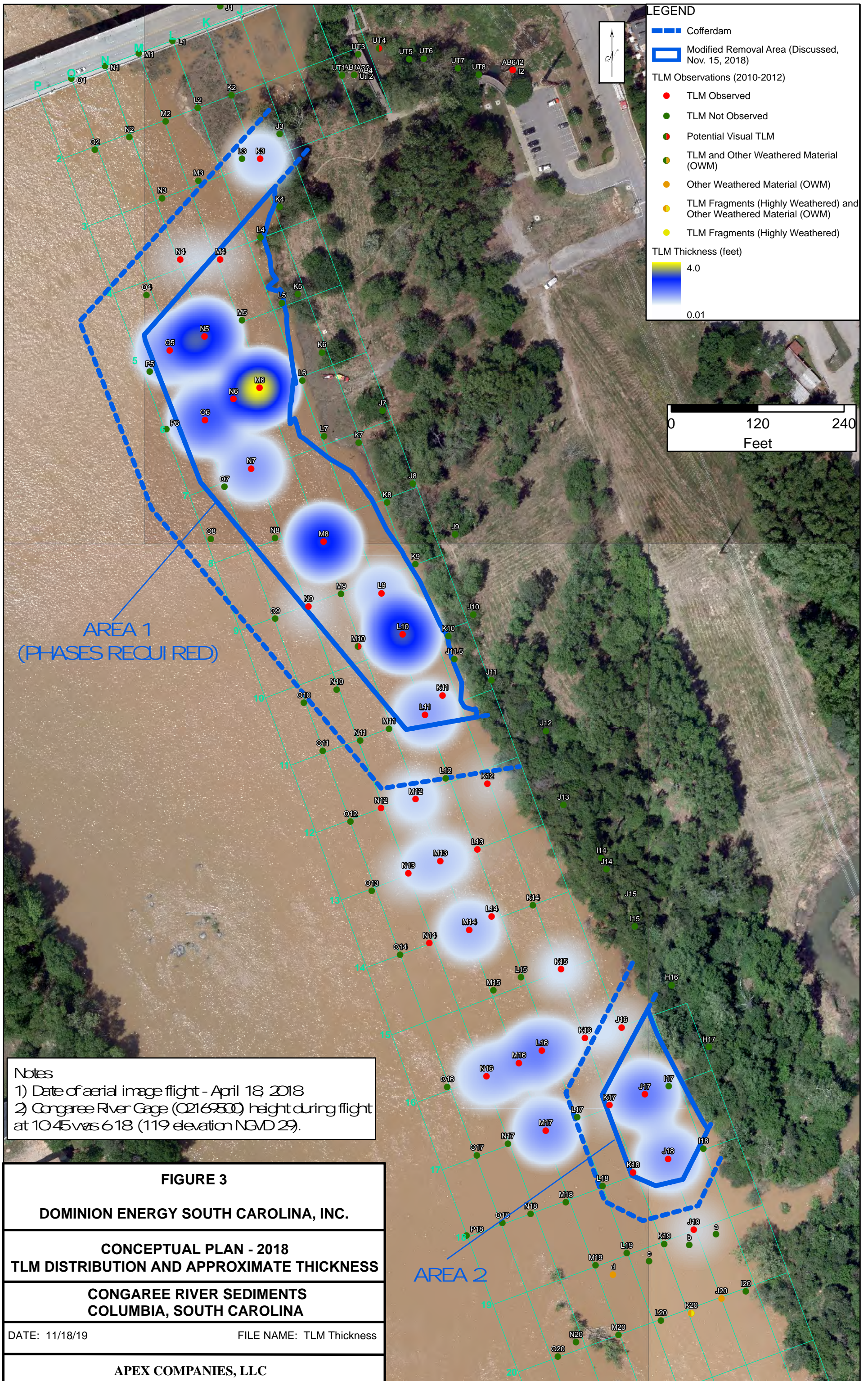

LEGEND

- Cofferdam
- Modified Removal Area (Discussed, Nov. 15, 2018)
- TLM Observations (2010-2012)**
- TLM Observed
- TLM Not Observed
- Potential Visual TLM
- TLM and Other Weathered Material (OWM)
- Other Weathered Material (OWM)
- TLM Fragments (Highly Weathered) and Other Weathered Material (OWM)
- TLM Fragments (Highly Weathered)

TLM Thickness (feet)

4.0
0.01



AREA 1
(PHASES REQUI RED)

AREA 2

Notes
 1) Date of aerial image flight - April 18, 2018
 2) Congaree River Gage (02169800) height during flight at 10:45 was 6.18 (119 elevation NGVD 29).

FIGURE 3

DOMINION ENERGY SOUTH CAROLINA, INC.

CONCEPTUAL PLAN - 2018
TLM DISTRIBUTION AND APPROXIMATE THICKNESS

CONGAREE RIVER SEDIMENTS
COLUMBIA, SOUTH CAROLINA

DATE: 11/18/19 FILE NAME: TLM Thickness

APEX COMPANIES, LLC

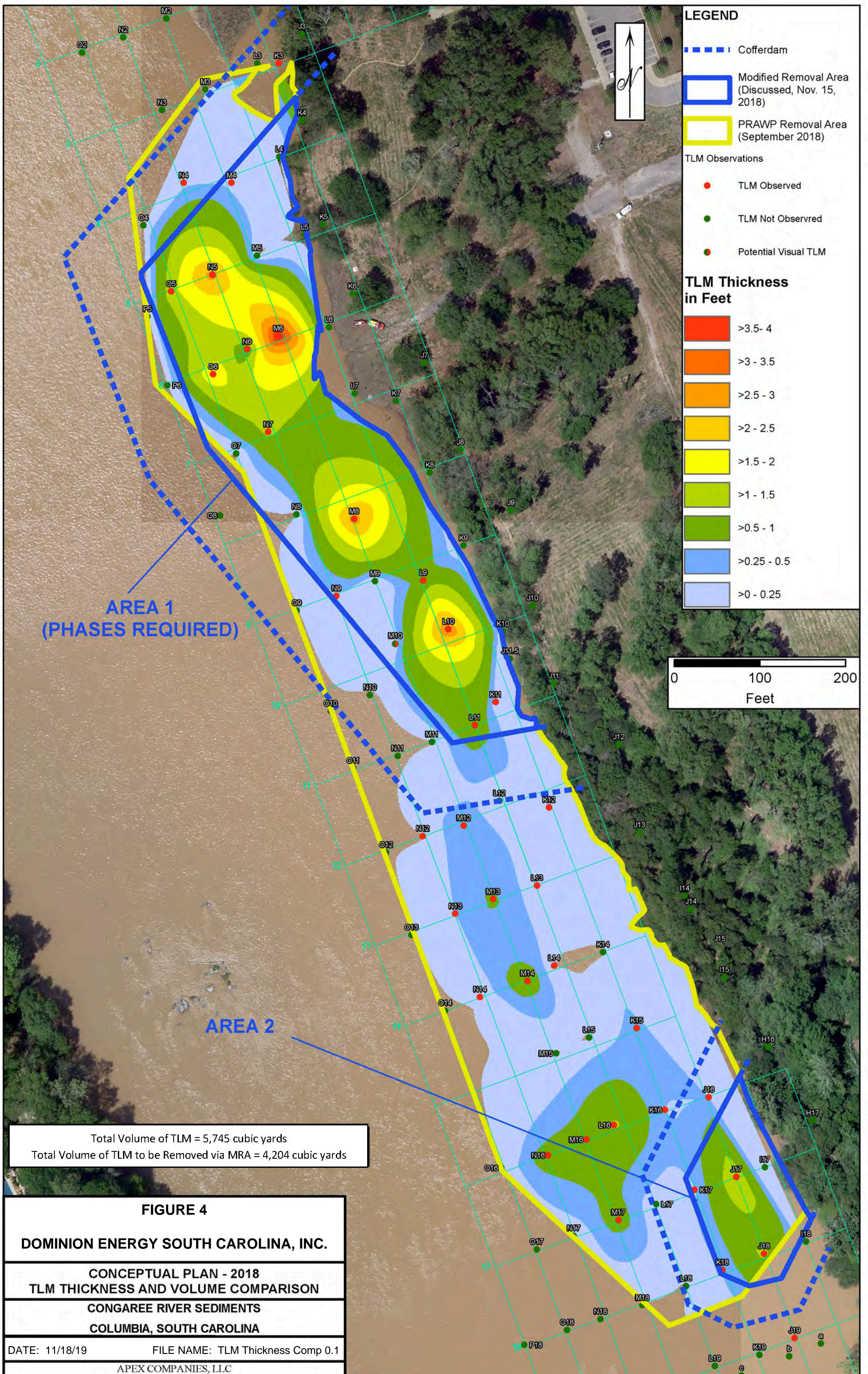

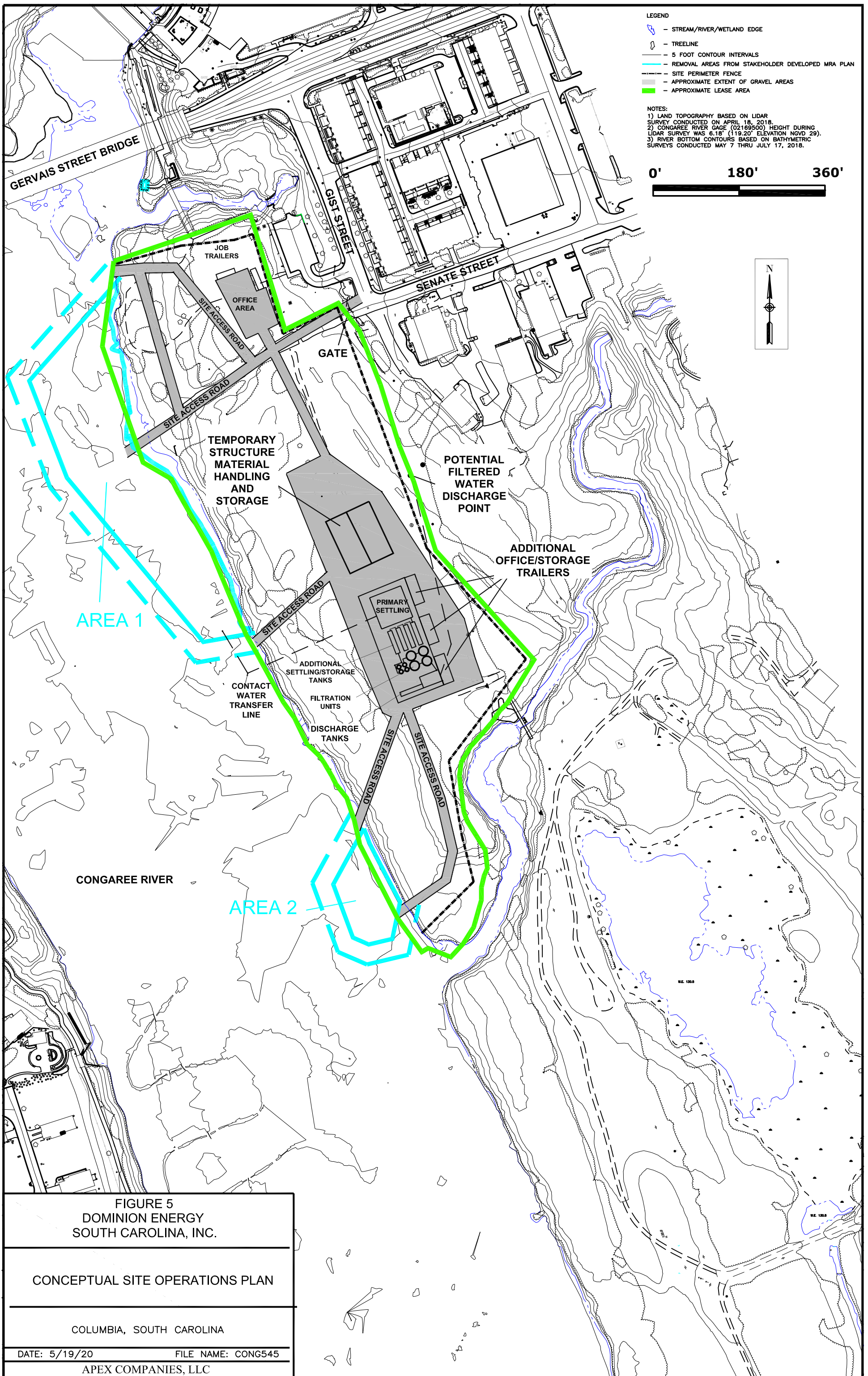

FIGURE 5
DOMINION ENERGY
SOUTH CAROLINA, INC.

CONCEPTUAL SITE OPERATIONS PLAN

COLUMBIA, SOUTH CAROLINA

DATE: 5/19/20

FILE NAME: CONG545

APEX COMPANIES, LLC

APPENDIX A

SCDHEC CORRESPONDENCE

- A-1 SCDHEC Letter to SCANA dated July 31, 2018
- A-2 SCDHEC Letter to SCANA dated October 22, 2018
- A-3 SCDHEC Letter to SEG dated February 7, 2019



July 31, 2018

Mr. Thomas Effinger
SCANA
Mail Code C-221
220 Operation Way
Cayce, SC 29033-3701

RE: Removal Action Alternative
SCE&G Fleet Maintenance Site (Congaree River)
Columbia, South Carolina

Dear Mr. Effinger:

As discussed at the July 20, 2018 stakeholder meeting, the Department requests that SCANA submit an updated work plan for the removal of the tar-like material within the Congaree River.

The work plan should include a description of the current knowledge of tar-like material and river sediment within the Congaree River project area. The submittal should incorporate three dimensional models as well as maps and/or cross sections to accurately portray the distribution of tar-like material, river sediment, and bedrock topography. The plan should also propose a method or methods to accomplish the removal and an estimate of the volume to be removed.

Please provide this submittal to the Department by September 15, 2018.

Sincerely,

G. Kendall Taylor, P.G., Director
Division of Site Assessment, Remediation, and Revitalization
Bureau of Land and Waste Management

cc: Mark Plowden, Deputy Chief of Staff, Office of Governor Henry McMaster
Mayor Stephen K. Benjamin, City of Columbia
Myra C. Reece, EA Director, SC DHEC
Veronica Barringer, Midlands EA Region
Bill Stangler, Congaree Riverkeeper
Tommy Lavender, Nexsen Pruet
File 52561

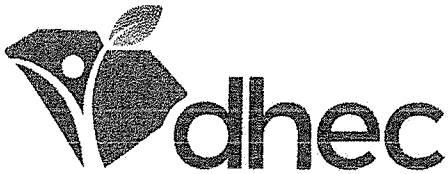

Healthy People. Healthy Communities.

October 22, 2018

Mr. Thomas Effinger
SCANA
Mail Code C-221
220 Operation Way
Cayce, SC 29033-3701

RE: Preliminary Removal Action Work Plan
SCE&G Fleet Maintenance Site (Congaree River)
Columbia, South Carolina

Dear Mr. Effinger:

The Department is in receipt of the Preliminary Removal Action Work Plan, dated September 17, 2018. The Department acknowledges SCANA's proposal to remove the coal tar from the Congaree River, and recognizes that a permit will be required from the US Army Corps of Engineers to implement the proposed remedy. Please keep us informed as you move forward with applying for this permit.

Sincerely,

A handwritten signature in black ink, appearing to read "Lucas Berresford".

Lucas Berresford, Program Manager
State Voluntary Cleanup Program
Division of Site Assessment, Remediation, and Revitalization
Bureau of Land and Waste Management

cc: Mayor Stephen K. Benjamin, City of Columbia
Myra C. Reece, EA Director
Veronica Barringer, Midlands EA Region
Bill Stangler, Congaree Riverkeeper
Tommy Lavender, NexsenPruett (for the Guinyard Family Trust)
File 52561



February 7, 2019

Mr. Thomas Effinger
Southeast Energy Group (SEG)
Mail Code C-221
220 Operation Way
Cayce, SC 29033-3701

RE: Draft Conceptual Plan for a Modified Removal Action (dated 12/12/18)
SCE&G Fleet Maintenance Site (Congaree River)
Columbia, South Carolina

Dear Mr. Effinger:

The Department (DHEC) has reviewed the Modified Removal Action (MRA) approach presented in the Draft Conceptual Plan and agrees this plan should be considered the preferred path-forward on the Congaree River sediment remediation project being conducted under DHEC's Responsible Party Voluntary Cleanup Contract (VCC 02-4295-RP.) This approach would target for removal areas where tar like material (TLM) is most prevalent and poses the greatest risk to human exposure. The target areas are shown in the three figures attached. It also acknowledges that some TLM might remain in the riverbed but situated in areas that would pose very little future risk to human exposure.

DHEC has consulted with two primary stakeholders in this project - The Congaree Riverkeeper and Guignard Associates LLC - and they too have expressed their support of this modified Removal Plan (see attached supporting statements for the record from each attached).

The Department requests SCE&G carry this proposal forward and draft all the proper documents to achieve the necessary regulatory permits and approvals required for implementation. Additionally, understanding that this project is being conducted under DHEC's Responsible Party Voluntary Cleanup Contract (VCC 02-4295-RP), stakeholder involvement and public participation will occur through the entire project. DHEC and the stakeholders agree that this project should be accomplished by the most expeditious route possible in working with the U.S. Army Corps of Engineers.

Sincerely,

G. Kendall Taylor, Director
Division of Site Assessment, Remediation, and Revitalization
Bureau of Land and Waste Management

cc: File 52561
Myra C. Reese, EA Director
Veronica Barringer, Midlands EA Region
Bill Stangler, Congaree Riverkeeper
Charlie Thompson, Guignard Associates LLC

Figures

LEGEND

- PRAWP Removal Area (September 2018)
- Modified Removal Areas (Discussed, Nov 15, 2018)
- Glenn Contours (2018)
- TLM Observations (2010-2012)
 - TLM Observed
 - TLM Not Observed
 - Potential Visual TLM

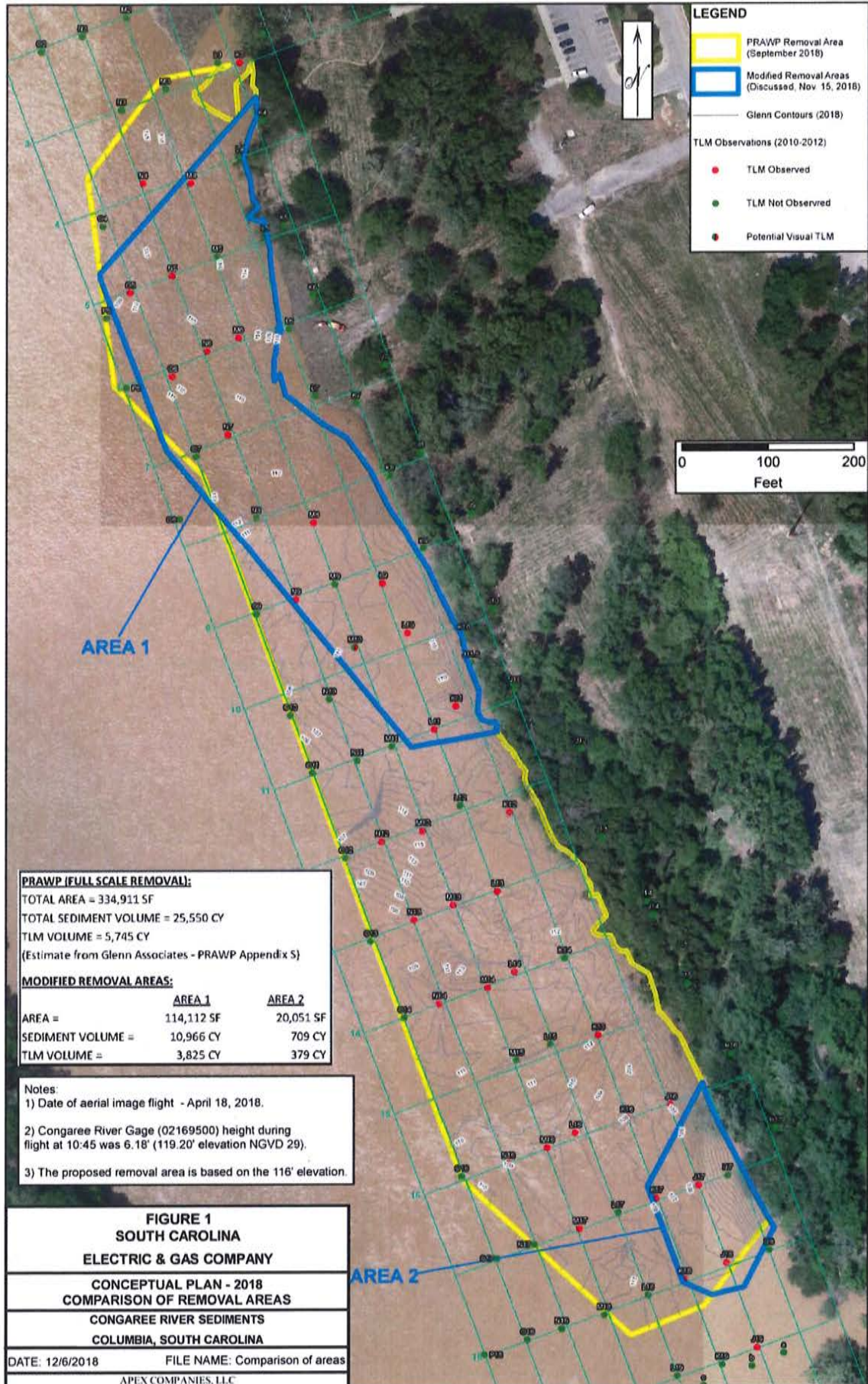

PRAWP (FULL SCALE REMOVAL):
 TOTAL AREA = 334,911 SF
 TOTAL SEDIMENT VOLUME = 25,550 CY
 TLM VOLUME = 5,745 CY
 (Estimate from Glenn Associates - PRAWP Appendix S)

MODIFIED REMOVAL AREAS:

	AREA 1	AREA 2
AREA =	114,112 SF	20,051 SF
SEDIMENT VOLUME =	10,966 CY	709 CY
TLM VOLUME =	3,825 CY	379 CY

- Notes:
- 1) Date of aerial image flight - April 18, 2018.
 - 2) Congaree River Gage (02169500) height during flight at 10:45 was 6.18' (119.20' elevation NGVD 29).
 - 3) The proposed removal area is based on the 116' elevation.

FIGURE 1
SOUTH CAROLINA
ELECTRIC & GAS COMPANY

CONCEPTUAL PLAN - 2018
 COMPARISON OF REMOVAL AREAS
 CONGAREE RIVER SEDIMENTS
 COLUMBIA, SOUTH CAROLINA

DATE: 12/6/2018 FILE NAME: Comparison of areas
 APEX COMPANIES, LLC

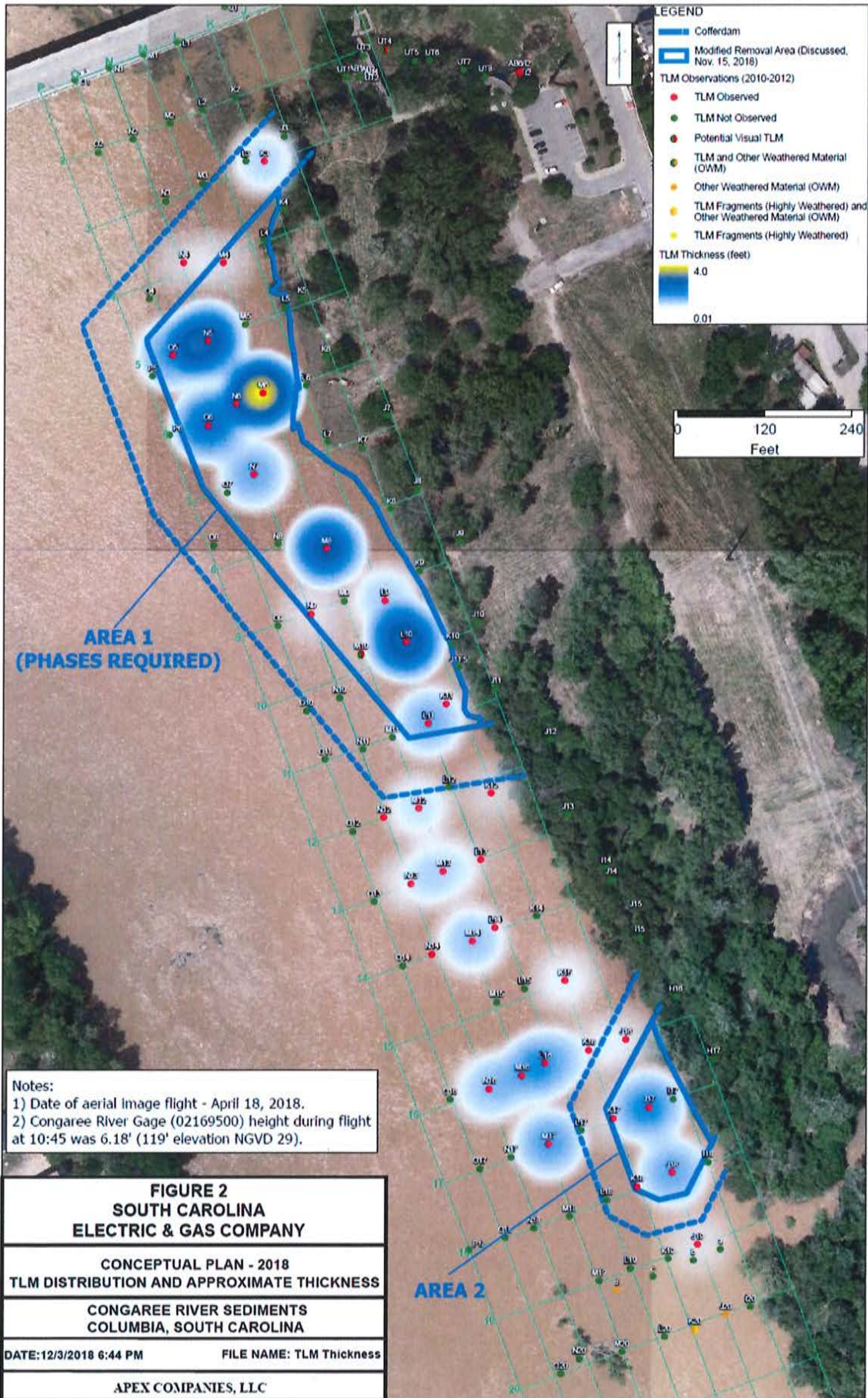

Notes:
 1) Date of aerial image flight - April 18, 2018.
 2) Congaree River Gage (02169500) height during flight at 10:45 was 6.18' (119' elevation NGVD 29).

FIGURE 2
SOUTH CAROLINA
ELECTRIC & GAS COMPANY

CONCEPTUAL PLAN - 2018
 TLM DISTRIBUTION AND APPROXIMATE THICKNESS

CONGAREE RIVER SEDIMENTS
 COLUMBIA, SOUTH CAROLINA

DATE: 12/3/2018 6:44 PM FILE NAME: TLM Thickness

APEX COMPANIES, LLC

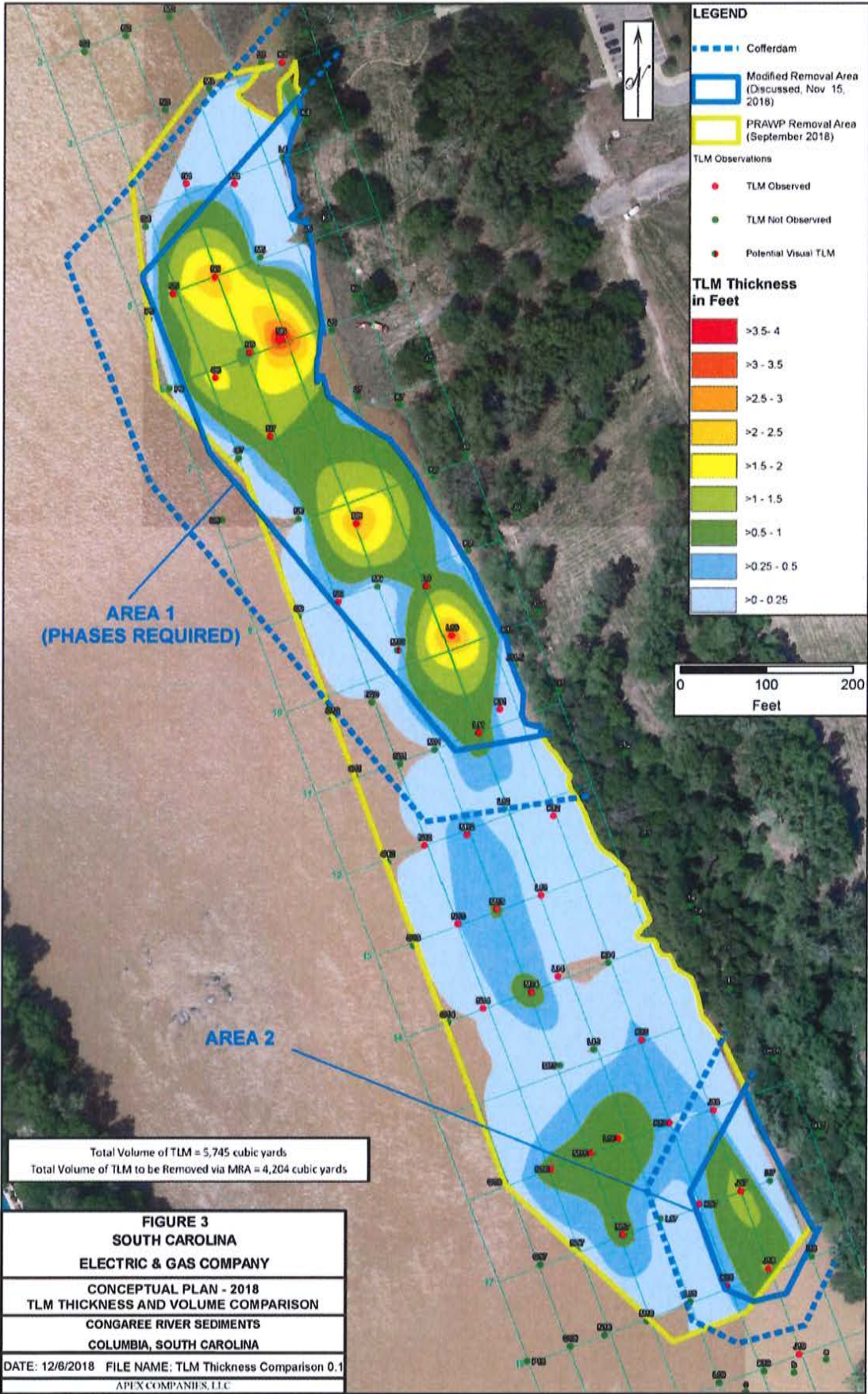

Declaration of Support by Stakeholders:

- 1) Congaree Riverkeeper endorses the modified removal action presented by SCE&G and described above, with the understanding that SCE&G will work diligently and make all reasonable efforts to acquire the necessary permits and complete this proposed removal action, and SCE&G will provide stakeholders with regular updates on their progress. We are also committed to supporting the permitting strategy the Corps determines is most appropriate for the Modified Removal Action, provided that the permit authorization process is as expeditious as possible while still affording sufficient opportunity -- either within the permitting process or through the parallel voluntary cleanup contract led by DHEC -- for public comment and for agency consultation.

William J. Stangler (e-signature, 1/23/19)

Bill Stangler
Congaree Riverkeeper

Declaration of Support by Stakeholders:

1. That any such plan and associated application be submitted to the USACE for authorization under the appropriate Nationwide permit, e.g., NWP-38, and not under an Individual permit, to expedite the process and help mitigate the total project timeline.



Charles C. Thompson, Manager
Guignard Associates LLC

APPENDIX B

COFFERDAM INSPECTION AND MAINTENANCE PLAN



COFFERDAM INSPECTION AND MAINTENANCE PLAN

**CONGAREE RIVER MODIFIED REMOVAL ACTION
COLUMBIA, SOUTH CAROLINA**

September 2020

Prepared for:

Dominion Energy South Carolina, Inc.
400 Otarre Parkway
Cayce, South Carolina 29033

Prepared by:

Apex Companies, LLC
1600 Commerce Circle
Trafford, PA 15085

COFFERDAM INSPECTION AND MAINTENANCE PLAN

CONGAREE RIVER MODIFIED REMOVAL ACTION COLUMBIA, SOUTH CAROLINA

INTRODUCTION

Dominion Energy South Carolina, Inc. (DESC), formerly South Carolina Electric and Gas Company (DESC), plans to complete a Modified Removal Action (MRA) to address the occurrence of a tar-like material (TLM) that is commingled with sediment along the eastern shoreline of the Congaree River, just south of the Gervais Street Bridge in Columbia, South Carolina. The project area location is shown on Figure 1. The TLM is believed to be a coal tar material that originated from the Huger Street former manufactured gas plant (MGP) site, located approximately 1,000 feet to the northeast of the project area. The proposed work is being performed by DESC at the direction of South Carolina Department of Health and Environmental Control (SCDHEC) and is subject to permits and approvals from the U.S. Army Corps of Engineers (USACE) and other agencies.

The overall objective of this project is to remove impacted sediment from the Congaree River within two areas. The current plan is to construct temporary cofferdams around each area to facilitate removal of the impacted sediment. As currently envisioned, the temporary cofferdams will be constructed sequentially and the MRA will occur over several years. The construction and active remediation season will occur from approximately May through October of each year. Figure 2 shows the current site operations plan scenario and the landside support zone components. Figure 3 illustrates the proposed cofferdam locations. After each cofferdam is constructed, the isolated area will be dewatered, and the impacted sediment removed and transported off-site for disposal. Following completion of the removal activities in Area 1, the cofferdam will be removed, and a cofferdam will be constructed around Area 2. After the removal activities are completed in Area 2, the cofferdam materials will be removed from the river.

COFFERDAM DESIGN AND STABILITY ANALYSIS

The cofferdam design was completed by WSP USA Inc. (WSP). The design drawings are provided as an attachment to the Joint Application submittal to the USACE. Some key elements of the cofferdam design that are applicable to this Plan include:

- Two reinforced cofferdam structures, to be installed separately around each removal area;
- Reinforcement of the structures using articulated concrete block (ACB) mats;
- An outlet structure, which provides drainage from inside the cofferdam following an overtopping event; and
- An overtopping structure for the Area 2 cofferdam, which is not required to be fully reinforced on the inboard side of the cofferdam due to more limited sediment thicknesses, that is intended to mitigate the impact of overtopping events.

The outlet structure will provide a significant means of dewatering the cofferdam area after an overtopping event. The outlet structure is an 18-inch diameter pipe that extends from within the cofferdam, through the wall of the cofferdam on the downgradient side, and into the river. A Tideflex (or equivalent) check valve will be installed at the discharge point.

A stability analysis was also completed by WSP and is included with the Joint Application submittal to the USACE. The stability analysis was prepared to analyze the stability of the proposed cofferdam as constructed with the planned materials above the river bottom, which consists of varying thicknesses of sediment overlying as rock bottom. The stability analysis was performed for flood loading conditions where the water level is assumed to be at the crest of the cofferdam. As shown in the calculations, the cofferdam design meets the required factor of safety.

As stated in the stability analysis, no additional analyses are required if the cofferdam is constructed as indicated and the design of the cofferdam is considered suitable for the conditions analyzed. As a supplement to that analysis, an evaluation of potential overtopping scenarios is provided in this Plan.

INSPECTION AND MAINTENANCE

Overview

Initial project activities will consist of constructing the landside support zone and installing the cofferdam around the Area 1 removal area. Area 2 will be addressed following the completion of activities within Area 1. Figure 2 shows the cofferdam locations, current site operations plan scenario and the landside support zone components. The landside support zone will consist of a series of gravel roads and equipment/material storage areas and temporary structures.

The cofferdams will be constructed around each removal area to isolate it from the remainder of the river and allow dewatering and removal of the impacted sediment. After the cofferdam is in place and the area dewatered, the sediment removal activities will commence. The cofferdam is designed to significantly restrict the flow of water into the planned work area, although it is not anticipated to be watertight. As a result, leakage water is expected to penetrate the cofferdam and will require management by remediation personnel on a daily basis.

During construction and use of the cofferdam, a number of factors will need to be routinely monitored to ensure that remediation personnel complete the project safely and that the cofferdam structure functions as intended. Two main factors that could adversely impact the cofferdam and the remediation process are leakage and overtopping events. Leakage will need to be closely monitored to ensure that dewatering activities are sufficient and that the water management system capacity is adequate. Overtopping events are situations when the river level will rise above the top of the cofferdam and flood the interior of the structure. A reinforced cofferdam structure was ultimately selected for this project due to its resistance to damage from overtopping events. In addition, the design elevation for the crest of the cofferdam (123.5 feet NGVD 29) will be sufficient to contain a significant increase in the river water height. However, overtopping is anticipated and advance notice will be important in order to evacuate personnel and equipment and secure exposed impacted material prior to being overtopped.

Real Time Inspections

Visual observations by on-site personnel will be the primary means for inspection of the cofferdam. During working hours, on-site personnel will serve as routine visual monitors to provide real time observations and detect any potential problems as they may arise. For non-working hours, site security officers will provide oversight and contact remediation personnel in the event of uncontrolled leakage or an overtopping event. Depending upon the actual leakage rate, remediation personnel may be required to staff the dewatering equipment 24 hours per day.

Personnel working at the site will maintain an awareness of the river conditions and the potential for overtopping events. As the river rises or the forecast is for additional precipitation, on-site personnel will increase their vigilance for monitoring the effects on the cofferdam.

Routine Inspections – Active Construction/Remediation Season

To ensure that the integrity of the cofferdam structure remains intact and that it adequately performs its intended functions, a competent member of the project team will conduct visual inspections of both the structure and surrounding area each workday during the active construction/remediation season. The inspections will initiate at the onset of the cofferdam construction activities and conclude after the final portion of the cofferdam is removed. Findings and observations will be documented, and the contractor will be advised on any recommended/required repairs. Specific components of the cofferdam and the MRA that will be evaluated during the inspections will include:

- Inspecting the exterior (riverside) of the cofferdam for damage, erosion or a buildup of debris such as logs or other items deposited by the river;
- Inspection of the two riverbank tie-in locations where the cofferdam structure meets the shoreline for erosion or other potential issues;
- Obtaining photographs of potential problem areas in need of repairs and post-repair documentation;
- Inspection of the navigational aids (e.g., restricted access signage, solar powered lights, river buoy locations) installed to ensure that the general public and other river users are aware of the cofferdam and its specific access restrictions and navigational requirements;
- Observation of the river height and comparison of this height to the gauge readings published by the USGS for gauge 02169500 located across the river (Figure 3);
- Review of the USGS projected river flows for that specific date and the next 5 days to obtain advance notice of any river height fluctuations that may impact the project;
- Monitoring of planned flow modifications from the Saluda River Hydroelectric Dam located approximately 12 miles upriver to determine if a change in release volumes is planned within the next several days;
- Qualitatively assessing the volume of leakage water and comparing this volume to the previous few days to determine if the leakage volume is increasing, decreasing or remaining relatively constant; and
- Identifying areas of significant leakage.

The cofferdam and removal area will be visually inspected each workday. An inspection form will be completed on each date and any potential areas in need of repairs will be documented. An example inspection form is provided as Attachment B. The daily form and a description/photographs of any area in

need of repairs will be provided to the contractor to be addressed as soon as practical. The form may be revised, if required, after the project begins to better meet the needs of the inspection/contractor personnel. Completion of the inspection activities and use of the inspection form/checklist will result in:

- Resolving potential issues with the cofferdam structure or work area in a timely manner; and
- Providing a means for tracking river level fluctuations in order to help prepare for potential overtopping events.

Inspections will also be undertaken following an overtopping event and will continue as the river levels subside. Potential cofferdam damage resulting from an overtopping event will be rectified as soon as practical to allow for efficient dewatering of the isolated area and continuation of sediment removal activities.

Routine Inspections – “Standby Mode”

After constructed, the cofferdam will remain in place until sediment removal activities are completed in that area. The active in-the-river construction season will be May through October. Cofferdam construction/relocation activities will be limited to this period. DESC has also requested permission to leave the cofferdam in-place and work behind the cofferdam year-round [if required and feasible], with minimal site activity projected during the months of December through April due to anticipated river levels.

Overtopping events are much more likely to occur in the “winter months” (e.g., December thru April), thereby limiting productivity. In the event that the cofferdam is overtopped during the winter months or the risk of overtopping becomes significantly increased, the project may enter a “standby mode”. When in standby mode, routine inspections (e.g., weekly, at a minimum) will still occur and the findings and observations will be documented, to the extent feasible given the cofferdam may be submerged under multiple feet of water. After the water has receded from overtopping events, the integrity of the cofferdam structure will be re-evaluated. With consideration of the long-range forecast, the decision will be made to either remain in standby mode or resume work activities within the cofferdam.

COFFERDAM OVERTOPPING EVALUATION

A summary of cofferdam overtopping scenarios is presented in Table 1. Three types of overtopping are considered:

- Minor overtopping event;
- Major overtopping event; and
- Catastrophic event.

Table 1 presents some additional information relative to each type of overtopping listed above and correlates the overtopping event to a general river elevation. The summary table evaluates the likely extent of impacts and provides an estimate of lost productivity.

LIST OF ATTACHMENTS

- A Tables and Figures
- B Cofferdam Inspection Form

ATTACHMENT A

TABLES AND FIGURES

Table 1	Summary of Cofferdam Overtopping Scenarios
Figure 1	Site Location Map
Figure 2	Conceptual Site Operations Plan
Figure 3	Area 1 and Area 2 Cofferdam Locations

TABLE 1

**SUMMARY OF COFFERDAM OVERTOPPING SCENARIOS
COFFERDAM INSPECTION AND MAINTENANCE PLAN**

**Congaree River MRA
Columbia, South Carolina**

Type of Overtopping	General River Elevation (feet NGVD 29)	Overtopping Height (feet)	Anticipated Extent of Impacts
Minor Overtopping Event	> 123.5 to 124.5	0 to 1	Minor erosion at the top of the cofferdam Minimal damage due to installation of reinforcement and drainage outlet structure Dewatering efforts would be significant, but manageable Minor damage to aids to navigation Estimated 1 week of lost productivity
Major Overtopping Event	> 124.5 to 130.5	1 to 7	Likely more impacts than a minor event, with more erosion at the top of the cofferdam The interface of the cofferdam and shoreline may be more susceptible to erosion Dewatering efforts would be substantial, but manageable Aids to navigation will likely be damaged or potentially lost and will need replacements Access roads into the removal area would likely sustain moderate damage Estimated 2 weeks of lost productivity
Catastrophic Event	> 130.5 and above	>7	More impacts than a major event, with more erosion at the top of the cofferdam The reinforcement is expected to keep the overall cofferdam structure in place The interface of the cofferdam and shoreline may be susceptible to erosion Drainage of support areas and dewatering efforts would be substantial Aids to navigation will likely be damaged or potentially lost and will need replacements Access roads into the removal area would likely sustain moderate damage Site support facilities could be inundated/damaged Estimated 3 weeks of lost productivity

Notes:

Comparisons are relative and actual conditions may vary.

The rate of increase in the Congaree River may affect the impact on the cofferdam.

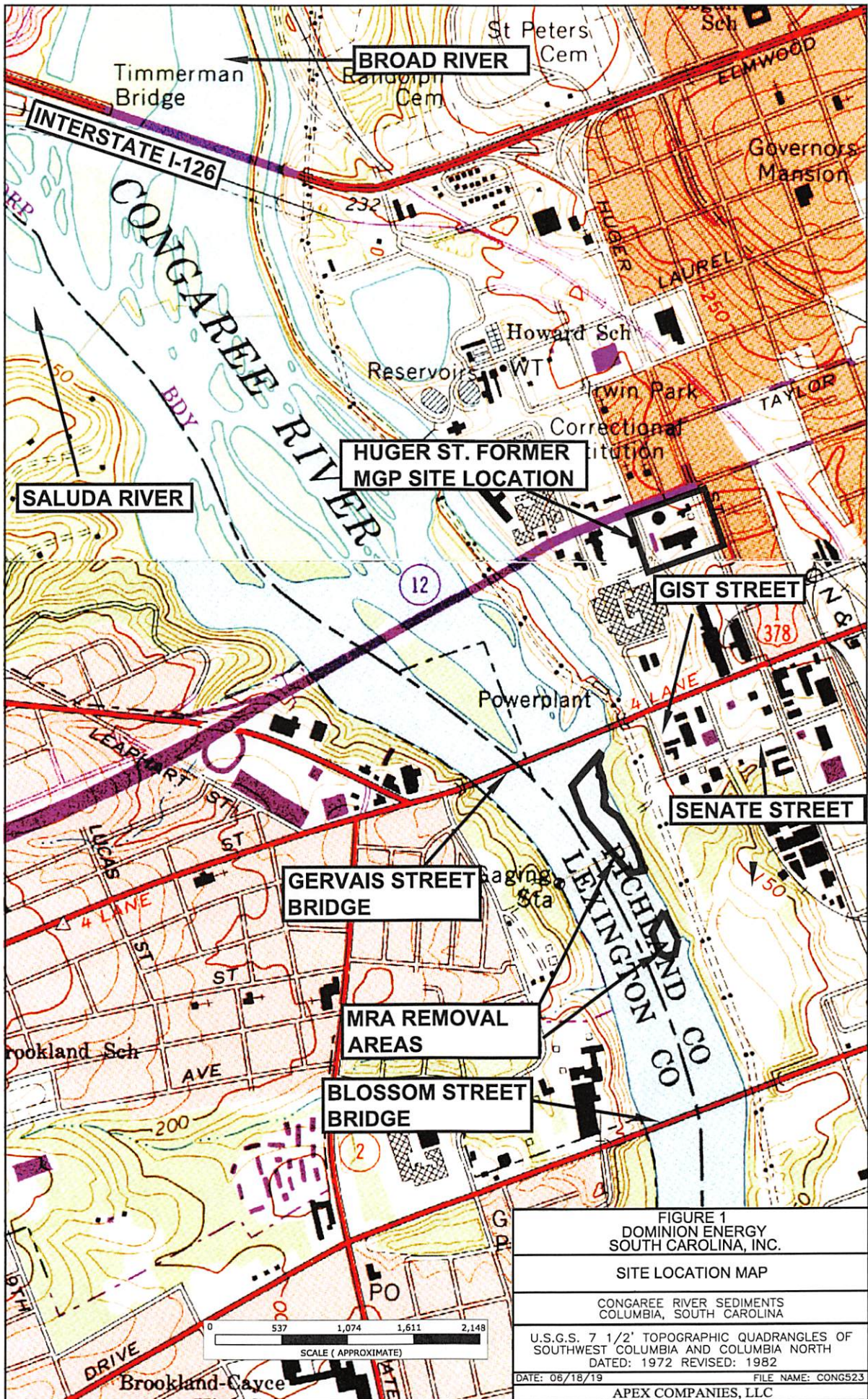

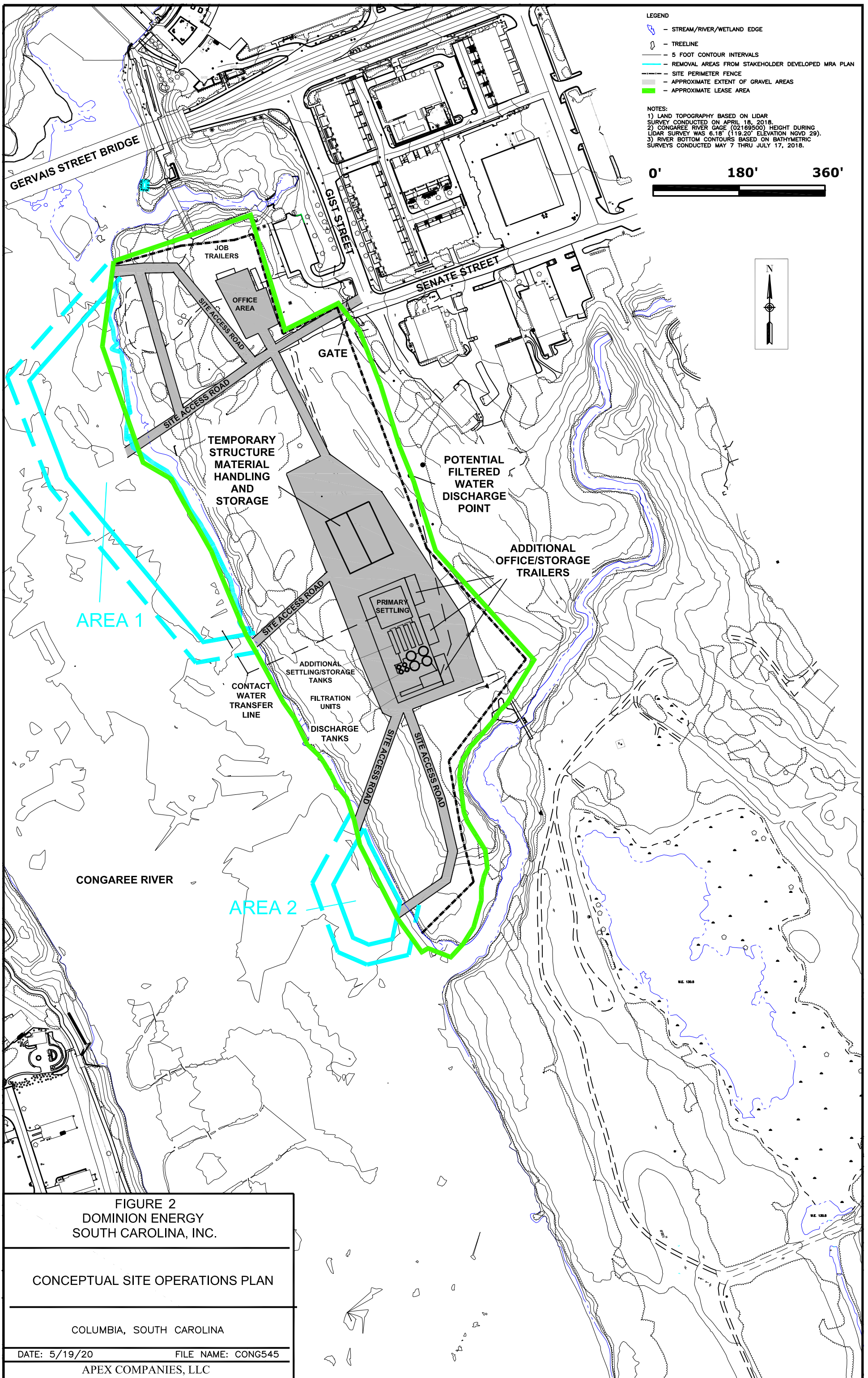

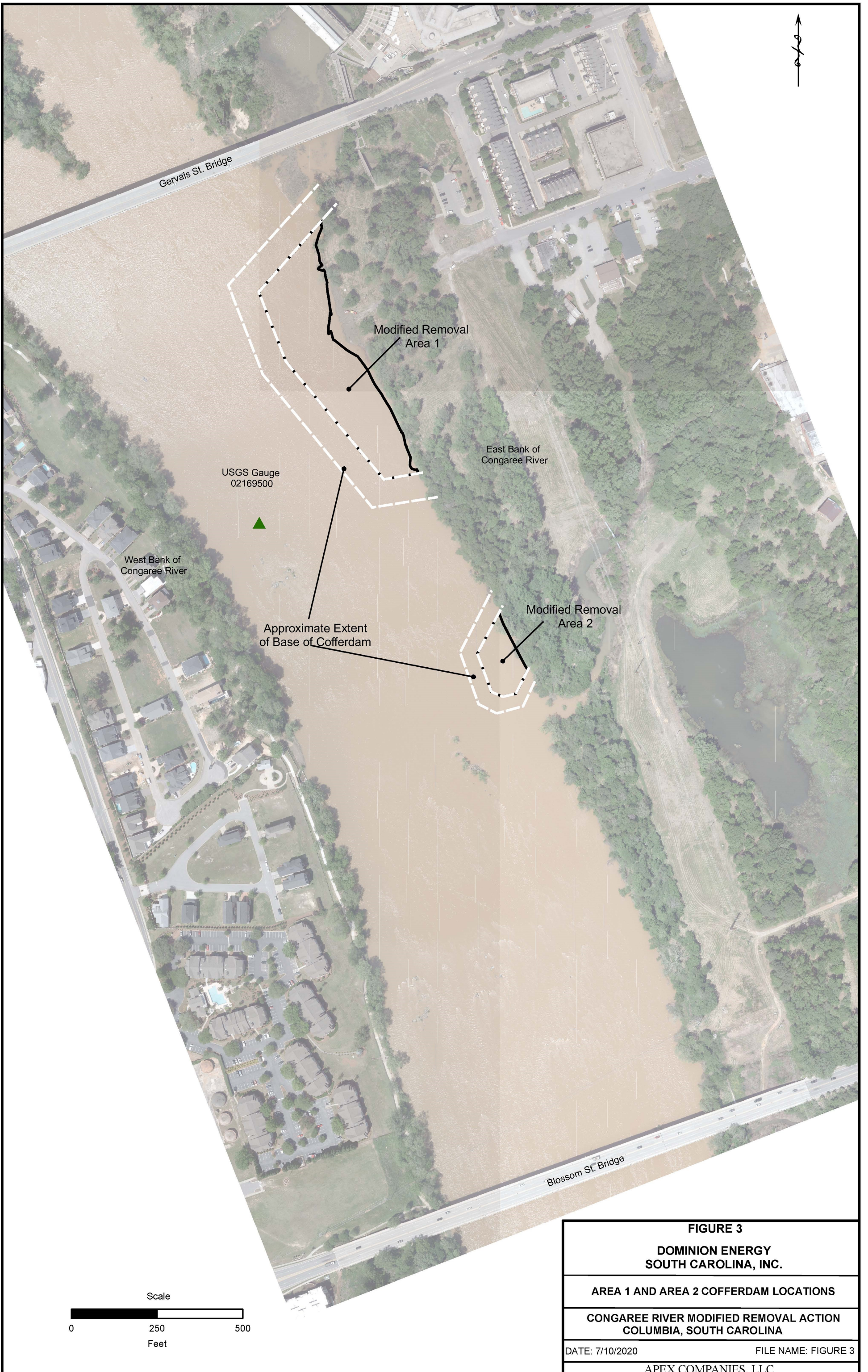

FIGURE 3	
DOMINION ENERGY SOUTH CAROLINA, INC.	
AREA 1 AND AREA 2 COFFERDAM LOCATIONS	
CONGAREE RIVER MODIFIED REMOVAL ACTION COLUMBIA, SOUTH CAROLINA	
DATE: 7/10/2020	FILE NAME: FIGURE 3
APEX COMPANIES, LLC	

ATTACHMENT B

COFFERDAM INSPECTION FORM



DAILY COFFERDAM INSPECTION

**Congaree River Sediments
Columbia, South Carolina**

Date: _____

Excavation Area: _____

Cofferdam exterior (riverside) intact and free of debris: _____

Shoreline and tie-in locations conditions: _____

Warning signs/buoys intact: _____

Areas of significant leakage: _____

Is leakage water volume: _____ increasing / decreasing / constant _____ (circle one)

Total Suspended (TSS) measurements completed this date: _____ Yes / No _____

TSS mitigation activities completed:

USGS River Gauge Reading: _____ (Gage "0" datum is 113.02')

NOAA river elevation prediction for next 5 days: _____

Planned changes in Saluda River Hydroelectric Dam release (next 5 days): _____

Additional notes/observations:

Signature of APEX Representative: _____

APPENDIX C

SITE OPERATIONS PLAN



SITE OPERATIONS PLAN

CONGAREE RIVER MODIFIED REMOVAL ACTION
COLUMBIA, SOUTH CAROLINA

September 2020

Prepared for:

Dominion Energy South Carolina, Inc.
400 Otarre Parkway
Cayce, SC 29033

Prepared by:

Apex Companies, LLC
1600 Commerce Circle
Trafford, PA 15085

SITE OPERATIONS PLAN

CONGAREE RIVER MODIFIED REMOVAL ACTION COLUMBIA, SOUTH CAROLINA

INTRODUCTION

Dominion Energy South Carolina, Inc. (DESC), formerly South Carolina Electric and Gas Company (SCE&G), plans to complete a Modified Removal Action (MRA) to address the occurrence of a tar-like material (TLM) that is commingled with sediment along the eastern shoreline of the Congaree River, just south of the Gervais Street Bridge in Columbia, South Carolina. The project area location is shown on Figure 1. The TLM is believed to be a coal tar material that originated from the Huger Street former manufactured gas plant (MGP) site, located approximately 1,000 feet to the northeast of the project area. The proposed work is being performed by DESC at the direction of South Carolina Department of Health and Environmental Control (SCDHEC) and is subject to permits and approvals from the U.S. Army Corps of Engineers (USACE) and other agencies.

The overall objective of this project is to remove impacted sediment from the Congaree River within two areas. The current plan is to construct temporary cofferdams around each area to facilitate removal of the impacted sediment. As currently envisioned, the temporary cofferdams will be constructed sequentially and the MRA will occur over several years. The construction and active remediation season will occur from approximately May through October of each year. Figure 2 illustrates the current site operations plan scenario and the landside support zone components. After each cofferdam is constructed, the isolated area will be dewatered, and the impacted sediment removed and transported off-site for disposal. Following completion of the removal activities in Area 1, the cofferdam will be removed, and a cofferdam will be constructed around Area 2. After the removal activities are completed in Area 2, the cofferdam materials will be removed from the river.

This Site Operations Plan provides a description of the planned general procedures to safely and effectively support the proposed sediment removal activities within the river. Several site preparation activities will take place prior to initiating the cofferdam construction and removal work. The conceptual approach to the Site Operations Plan is summarized on Figure 2. Some variations to the plan may occur, depending on site conditions encountered at the time MRA activities are initiated. The actual layout for site operations will be finalized at the discretion of remediation personnel provided DESC, SCDHEC and the landside property owner concur with any significant modifications.

The project will involve two main site operational areas:

- Landside Support Zone – includes the site entrances, roadways, office structures, material and equipment storage areas, excavated material management areas and water management system.
- Riverside Removal Areas – includes the cofferdam structures and excavation areas within the river.

Site operations components associated with the landside support activities are described in this Plan. The riverside activities are described in attachments to the Joint application submittal to the ACE and include:

- . Cofferdam Design Drawings (Attachment B);
- . Project Description (Attachment C);
- . Draft Navigation Plan (Attachment G);
- . Mussel Relocation Plan (Attachment H);
- . Artifact Recovery Plan (Attachment M);
- . UXO Management Plans (Attachment N); and
- . Restoration Operation, Maintenance and Monitoring Plan (Attachment P).

LANDSIDE SUPPORT ZONE COMPONENTS

Support Zone Construction

As currently envisioned, establishment of the access points and associated improvements will be one of the first components completed in the field. The currently planned landside support zone roadways and temporary structures scenario is provided on Figure 2. This scenario may be modified, as needed, to best utilize the space available. Landside site operations components will be placed and constructed in such a manner as to require as little clearing and grading activities as possible. The primary planned location for the majority of site operations is the power line right-of-way, which is already cleared. DESC relocated the overhead wires that were previously located within the right-of-way to accommodate future site operations. This scenario will reduce disturbance of currently forested land and further preserve the riparian corridor.

Road construction will be completed as well as placement of temporary site office trailers, storage trailers, temporary structures and installation of electrical and communication utility connections as described further in this Plan.

Utility Clearance and Management

A number of utilities are present within the planned project area. For the landside support zone, the overhead high voltage electrical transmission lines were relocated by DESC to provide more clearance for site operations and the temporary structures. Underground utilities within the landside support zone footprint include buried fiber optic communication lines, a sanitary sewer and an underground gas line. DESC believes that all underground utilities have been identified and located. However, to be consistent with the applicable regulations and confirm current locations, a request for clearing and identifying potential underground utilities at the site will be submitted to South Carolina 811 (Palmetto Utility Protection Services, Inc.) prior to initiating landside support zone construction activities. On-site personnel will be made aware of the buried utility locations. Support zone construction activities will consist of mainly relatively shallow surficial grading activities, which are not expected to impact buried utilities. If deeper excavations are required, they will be conducted in areas free of buried utilities.

A sign indicating a “cable crossing” is located on the eastern shoreline of the river just south of the current access road. A group of metallic anomalies was detected extending out into the river from this point during completion of the investigative phase of this project. Despite previous attempts, DESC has not been able to determine the owner, type, construction or current status of the cable crossing. Additional attempts to identify the cable crossing will be made and appropriate safeguards will be taken based on available information.

Demarcation of Historic and Archaeological Sites

An archaeologist will locate historic and archaeological site locations within the landside operations area and they will be sufficiently demarcated and avoided to the extent practicable during implementation of the project. Should disturbance of these areas become necessary, proper precautions will be undertaken similar to the plans developed for the protection of other locations of historical significance.

Evaluation and Demarcation of Plant Species of Concern Locations

The power line corridor is a potential habitat for the smooth coneflower and Georgia Aster, and portions are currently planned for use for landside support activities. During site operations setup activities, the corridor will be evaluated for the presence of smooth coneflower and Georgia Aster. If identified, their location will be demarcated and avoided to the extent practicable during implementation of the project. Should disturbance of these locations become necessary, these plants will be protected or relocated to the extent practical.

Site Office Location

Multiple mobile office and storage trailers will serve as the site offices and meeting/break areas during the MRA activities. The locations of the office and storage trailers will vary based on their functions and the currently envisioned locations are provided on Figure 2. These functions include office and meeting areas, break rooms, restroom and shower facilities and equipment storage. Several trailers will likely be placed near the temporary structures in order to provide office and shower facilities for the artifact recovery and impacted material handling personnel. Storage trailers may be located near the water management system to house equipment, pumps, etc. The main group of office trailers will be located near the entrance at the corner of Senate and Gist Streets and serve as general work and meeting locations. A final trailer(s) location will be near the work area and will provide meeting and break locations for remediation, UXO and other personnel near the actual work zones. The final number and locations of the trailers will be finalized prior to implementation and utility connection. The trailers will be provided with utilities as necessary including electric power, internet service, air conditioning, heating, a supply of drinking water and adjacent sanitary facilities. Cellular telephones will be utilized for site communications. If practical, the shower trailers will be connected to the City of Columbia municipal potable water system and also connected to the sanitary sewer.

Site Security

An important component of the overall project will be site security. The primary method for securing the site will be the installation of a temporary chain link fence around the perimeter of the landside support zone. “Restricted Area” signs will be posted at regular intervals along the fence and also posted on the cofferdam structure. The approximate fence location is shown on Figure 2. One locking gate, located at the corner of Senate and Gist Streets, will restrict vehicular traffic into and away from the project area.

Man gates will be positioned at regular intervals along the perimeter of the fence to permit site personnel to access the exterior of the fenced area when necessary.

To prevent the unauthorized or unknowing entry of third parties onto the site, access gates will remain closed during active site operations to the extent practical. The gates will remain locked during non-working hours.

Once site operations are initiated, DESC will also post security guards on-site during non-working hours. DESC has previously successfully utilized off-duty City of Columbia police officers as security guards during implementation of the Field Demonstration Project in 2015 and at other local sites. These guards will conduct regular patrols of the property during non-working hours and at times of low site activity when a minimal number of site personnel are present. The guards and fence will serve to keep unauthorized and untrained personnel out of the active project area.

Stormwater Management and Sediment Controls

Erosion and sediment (E&S) control best management practices (BMPs) for the landside portion of the project will be identified in the Comprehensive Site Stormwater Pollution Prevention Plan (C-SWPPP), which will be included with the Notice of Intent (NOI) for coverage under the South Carolina National Pollutant Discharge Elimination System (NPDES) General Permit for Stormwater Discharges from Construction Activities. The NOI and C-SWPPP will be reviewed and approved by the City of Columbia prior to initiation of land disturbance activities. The C-SWPPP will include Stormwater Management and Sediment Control Plan (SMSCP) drawings. The draft SMSCP is provided as Attachment K in the Joint Application submittal to ACE. The NPDES and C-SWPPP requirements will be maintained throughout completion of the project. The C-SWPPP and NPDES permit as well as other pertinent documentation will be available for review on-site at all times.

In general, the E&S BMPs specified in the C-SWPPP will be the first construction components installed and the last to be removed. The E&S controls will include the use of silt fence or sediment socks or similar devices, drainage structures, sufficient access and roadway construction, and other measures as may be required. Temporary roadways will be constructed, as needed, to prevent the spread or release of sediments from the work area. No tracking of mud or soil will be permitted beyond the site access gates. Any such impacts will be addressed immediately through the use of street-sweepers or power brooms that will be stationed on-site at all times during completion of the project. Silt fence or sediment socks or similar devices will be deployed and maintained, as required, to prevent sediment run-off from all disturbed areas. Remediation personnel will install and periodically inspect and repair the E&S BMPs identified in the C-SWPPP in accordance with the Plan's requirements. Deficiencies will be documented and corrected as soon as practical.

Work Zones

The exclusion zones will contain the specific areas where intrusive work is being conducted or TLM-impacted material is being handled. These areas will include the active sediment removal areas within the cofferdam and the temporary structure where impacted material screening will be completed. Access to the exclusion zones will be limited to trained environmental remediation personnel. Decontamination procedures will be implemented whenever equipment or personnel leave the exclusion zones on an as-needed basis to control the potential migration of constituents of concern from the work area. Equipment decontamination facilities will be available in the general work area. As necessary, a boot wash area will

also be maintained at the exclusion zone boundary to control tracking of potentially impacted material across the site.

Other work zones will be determined in the field, as necessary. These areas are expected to include:

- Traffic zones for loading of trucks, construction material drop-off/delivery, delivery/pickup of roll-off boxes, etc.;
- Staging areas for equipment and material;
- Water management area; and
- Support zones outside of the primary work areas.

Traffic Control

Only authorized remediation personnel will be allowed access to the work areas during the sediment removal activities. It is anticipated that most work traffic in support of the MRA activities will be routed through the site entrance at the corner of Senate and Gist Streets. Specific routes into and away from the project area will be established and followed by all project related vehicles.

On-site traffic patterns will be restricted to the site roads. Trucks transporting sediment from the removal areas to the temporary structure will be inspected before they leave the river area to ensure that the tires have not contacted impacted material or the impacted material has been removed. Similar inspections will be conducted before the trucks leave the temporary structure in order to return to the removal area or to travel off-site to the disposal facility. As an alternative, dedicated trucks may be utilized for on-site transport of material to further minimize the potential for tracking of impacted material off-site. Plastic-lined loading areas will be utilized for roll-off box or truck loading operations at both the river and temporary structure. This will prevent potential migration of impacted material from the removal and material handling areas.

Staging Areas

Staging areas for the gravel road construction or cofferdam material components will be established, as needed. These will be strategically located in order to provide an efficient means of moving construction material from the staging area to the road or cofferdam construction locations. Staging of excavated sediment outside of the active river work area or outside of the designated material handling areas (e.g., the temporary structure) will not be permitted. Any accumulated debris along the outbound surface of the cofferdams will be managed as needed. If necessary, the debris will be removed and temporarily staged for off-site disposal with excavated sediment.

Currently, DESC plans to prepare the surface of the temporary structure by clearing the current surface vegetation and grading and compacting the planned floor area. The surface will be constructed by placing a heavy mil plastic or HDPE liner over the subgrade as a containment barrier, covering the liner with geotextile for protection against punctures and creating the work surface out of compacted gravel. Concrete or asphalt may also be utilized as a work surface within the structures, if required. Either construction method will effectively contain the impacted sediment, provide an area where it can be further processed and prevent constituent migration. The surface material will be removed and transported to the landfill for disposal at the end of the project.

The currently planned location for the water management system is shown on Figure 2. The specific details pertaining to the system, the types of water and the management methods are provided in the Water Management Plan (Project Description - Appendix D). The water management system's primary role is to collect, filter and prepare for POTW discharge the water that comes into contact with impacted sediment. The water management system will be sized accordingly to minimize the potential for downtime due to dewatering requirements. The system will be operated as required to maintain an acceptable discharge rate. The components of the water management system will likely consist of water storage tanks (e.g., 20,000 gallon frac tanks and/or larger volume modular tanks), filtration equipment such as bag filters and/or activated carbon vessels, associated piping and hoses and a totalizing flow meter. The storage tanks will provide flow equalization and provide residence time to allow for settling of solids. The final design for the water management system will be submitted to the City of Columbia for review as part of the industrial discharge permit request. For illustrative purposes, the general water management scenario for Area 1 is provided on Figure 3. A similar scenario is expected to be utilized for water management in Area 2. The planned discharge location is a sanitary sewer manhole located near the eastern perimeter of the landside support zone shown on Figure 3.

As a contingency measure, DESC may construct an off-site material processing facility at the final disposal location for the excavated sediment, which is currently planned at the Waste Management Richland County landfill. The primary purpose of the facility would be to provide a secondary location where sediment containing a significant amount of TLM can be screened for artifacts and further processed. If utilized, this contingency location will provide the following benefits to the project:

1. Increased material processing capacity, which will allow for more expedient removal of the sediment within the isolated areas and reduction in the overall project completion time which will also reduce the project's exposure to costly overtopping events;
2. Reduction in the potential for constituent migration from heavily impacted material in the landside support zone;
3. Reduction in the potential for odor and air monitoring related issues from the more heavily impacted material; and
4. Provide an environment where more thorough screening of excavated material for artifacts can be accomplished.

In order to accomplish this two-pronged material processing and screening activity, the sediment containing significant amounts of TLM will be segregated as much as practical at the point of excavation, adequately stabilized and loaded directly into roll-off boxes or designated trucks that will carry it to the off-site processing facility. Sediment with TLM content that is manageable on-site will also be stabilized and loaded into roll-off boxes or trucks for transport to the landside support zone temporary structure for additional screening for artifact recovery. Segregation will be based on visual inspection at the point of excavation and determination of on-site vs. off-site processing will be made by field personnel. The Historical Artifacts Management Plan (Attachment M of the Joint Application submittal) provides the specific details pertaining to the further screening and processing of the sediment material that will occur after removed from the river.

ATTACHMENT A

Figures

- Figure 1 Project Area Location
- Figure 2 Conceptual Site Operations Plan
- Figure 3 Water Management Scenario

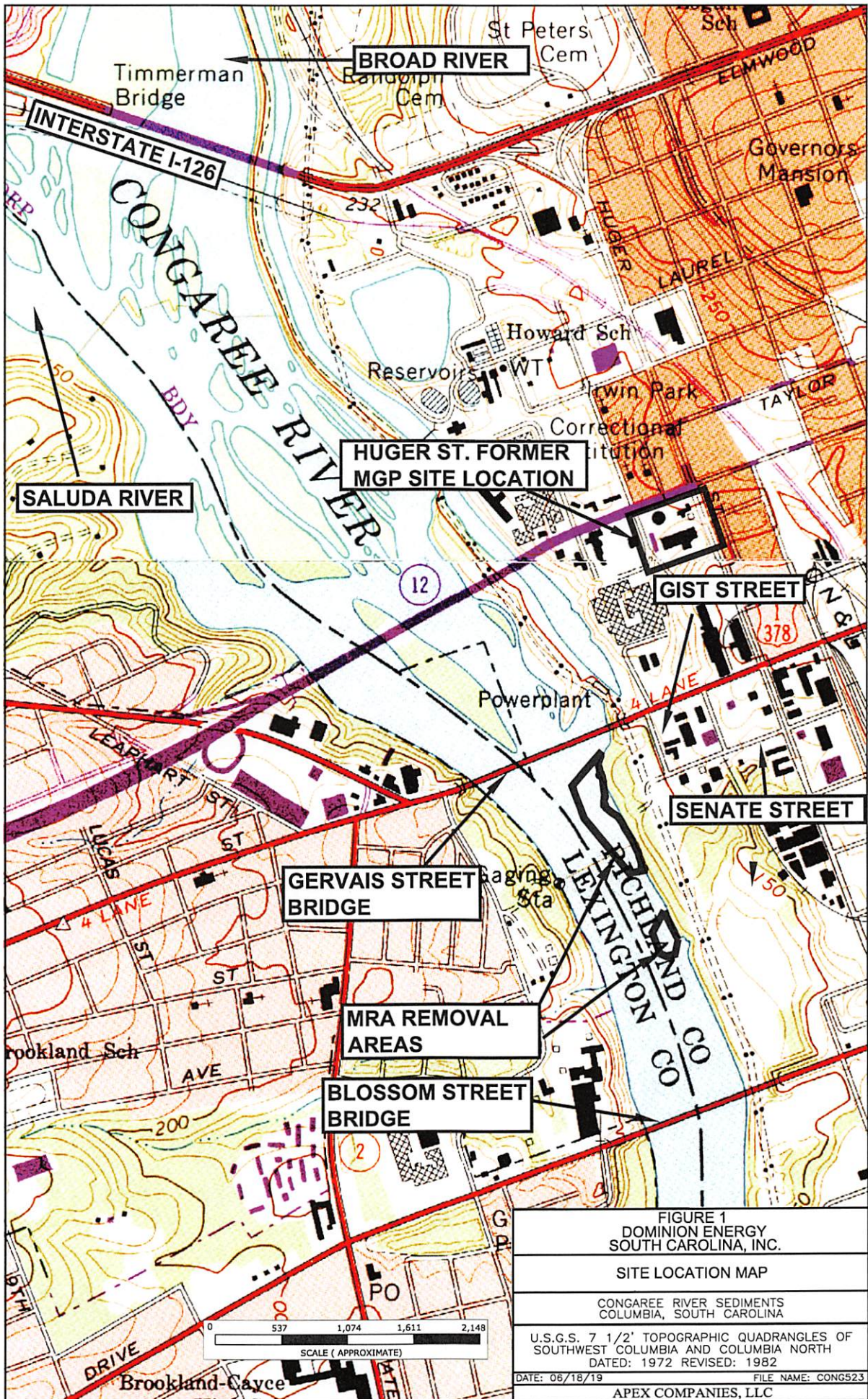

FIGURE 1
DOMINION ENERGY
SOUTH CAROLINA, INC.

SITE LOCATION MAP

CONGAREE RIVER SEDIMENTS
COLUMBIA, SOUTH CAROLINA

U.S.G.S. 7 1/2' TOPOGRAPHIC QUADRANGLES OF
SOUTHWEST COLUMBIA AND COLUMBIA NORTH
DATED: 1972 REVISED: 1982

DATE: 06/18/19

FILE NAME: CONG523

APEX COMPANIES, LLC

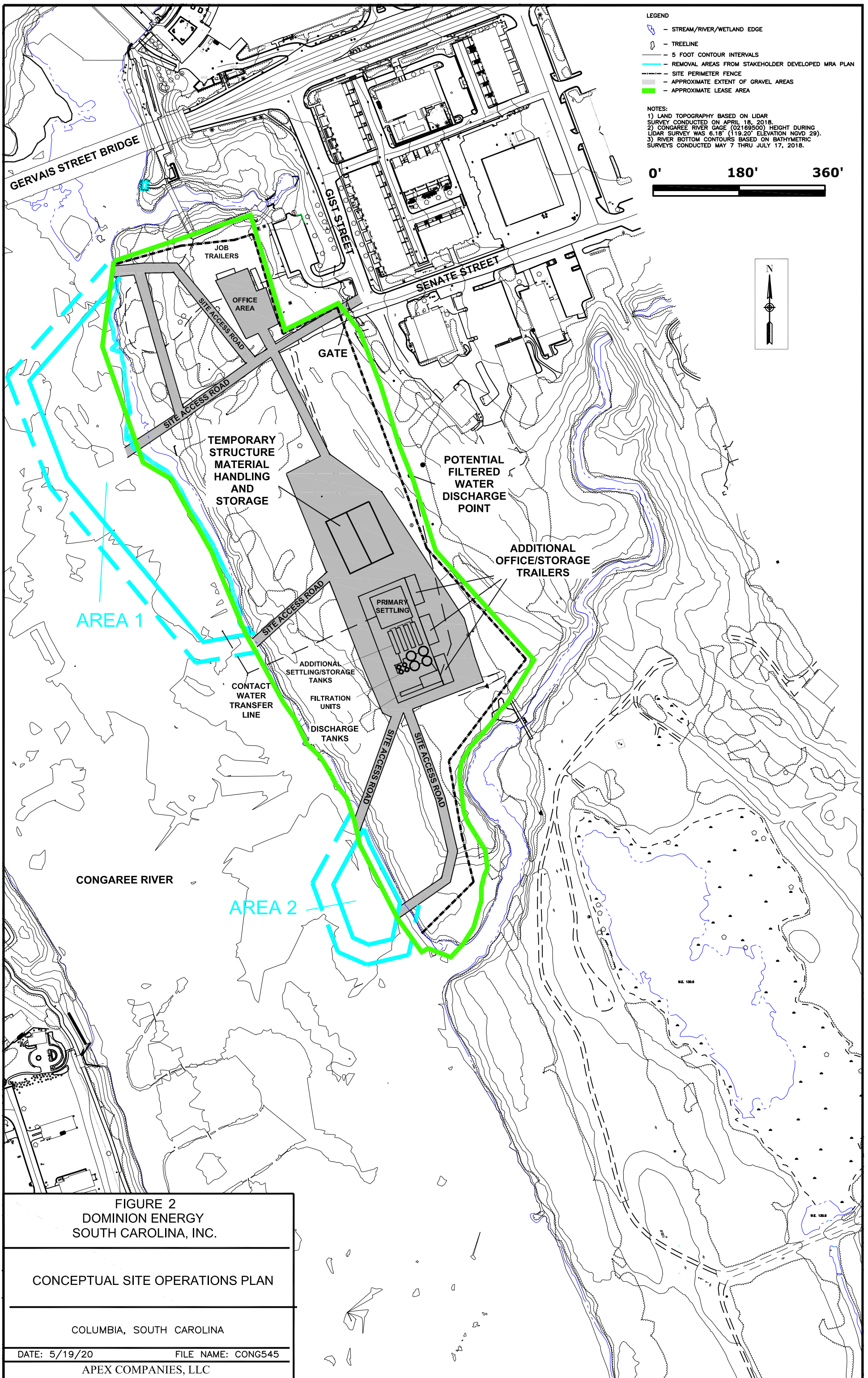

FIGURE 2
DOMINION ENERGY
SOUTH CAROLINA, INC.

CONCEPTUAL SITE OPERATIONS PLAN

COLUMBIA, SOUTH CAROLINA

DATE: 5/19/20

FILE NAME: CONG545

APEX COMPANIES, LLC

LEGEND

- GRAVEL AREA
- CONTACT WATER MANAGEMENT COMPONENT
- LEAKAGE WATER MANAGEMENT COMPONENT

- 1) ACTUAL LOCATIONS OF COLLECTION AND DISCHARGE POINTS WILL BE DETERMINED IN THE FIELD DURING IMPLEMENTATION.
- 2) SEDIMENT WILL BE REMOVED FROM THE LEAKAGE CONTROL DRAINAGE AND COLLECTION AREAS PRIOR TO CONSTRUCTION OF THE CURB.
- 3) LEAKAGE CONTROL WATER WILL BE VISUALLY INSPECTED PRIOR TO DISCHARGE.
- 4) IMPACTED WATER WILL BE TRANSFERRED TO WATER MANAGEMENT SYSTEMS TO DISCHARGE TO THE SANITARY SEWER SYSTEM.
- 5) OUTLET STRUCTURE WILL BE UTILIZED FOR INITIAL DISCHARGE OF WATER FOLLOWING COFFERDAM CONSTRUCTION OR OVERTOPPING EVENT.

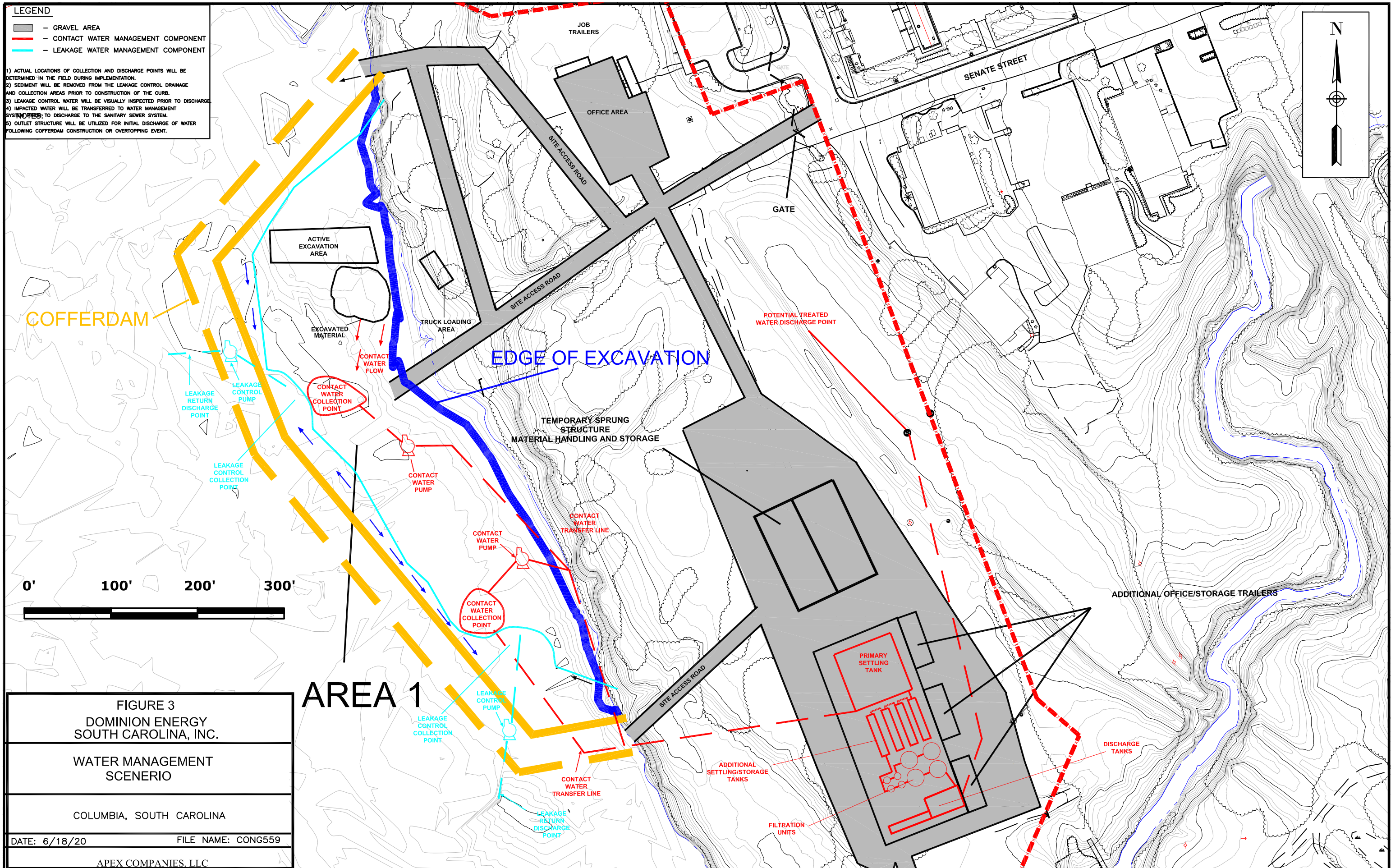

FIGURE 3
DOMINION ENERGY
SOUTH CAROLINA, INC.
WATER MANAGEMENT
SCENERIO
COLUMBIA, SOUTH CAROLINA
DATE: 6/18/20 FILE NAME: CONG559
APEX COMPANIES, LLC

APPENDIX D

WATER MANAGEMENT PLAN



WATER MANAGEMENT PLAN

CONGAREE RIVER MODIFIED REMOVAL ACTION
COLUMBIA, SOUTH CAROLINA

September 2020

Prepared for:

Dominion Energy South Carolina, Inc.
400 Otarre Parkway
Cayce, SC 29033

Prepared by:

Apex Companies, LLC
1600 Commerce Circle
Trafford, PA 15085

WATER MANAGEMENT PLAN
CONGAREE RIVER MODIFIED REMOVAL ACTION
COLUMBIA, SOUTH CAROLINA

INTRODUCTION

Dominion Energy South Carolina, Inc. (DESC), formerly South Carolina Electric and Gas Company (SCE&G), plans to complete a Modified Removal Action (MRA) to address the occurrence of a tar-like material (TLM) that is commingled with sediment along the eastern shoreline of the Congaree River, just south of the Gervais Street Bridge in Columbia, South Carolina. The project area location is shown on Figure 1. The TLM is believed to be a coal tar material that originated from the Huger Street former manufactured gas plant (MGP) site, located approximately 1,000 feet to the northeast of the project area. The proposed work is being performed by DESC at the direction of South Carolina Department of Health and Environmental Control (SCDHEC) and is subject to permits and approvals from the U.S. Army Corps of Engineers (USACE) and other agencies.

The overall objective of this project is to remove impacted sediment from the Congaree River within two areas. The current plan is to construct temporary cofferdams around each area to facilitate removal of the impacted sediment. As currently envisioned, the temporary cofferdams will be constructed sequentially and the MRA will occur over several years. The construction and active remediation season will occur from approximately May through October of each year. Figure 2 illustrates the current site operations plan scenario and the landside support zone components. After each cofferdam is constructed, the isolated area will be dewatered, and the impacted sediment removed and transported off-site for disposal. Following completion of the removal activities in Area 1, the cofferdam will be removed, and a cofferdam will be constructed around Area 2. After the removal activities are completed in Area 2, the cofferdam materials will be removed from the river.

WATER MANAGEMENT

Management of water will be a major component of the overall remediation project. This Water Management Plan provides details on the anticipated procedures to be implemented during remediation activities. For implementation purposes, water to be managed has been divided into two categories: non-contact water and contact water. Non-contact water is visually unimpacted water that has not been in contact with TLM or impacted sediments. It includes water from initial dewatering or overtopping events, cofferdam leakage, landside stormwater run-on, and non-contact removal area water including precipitation within the cofferdams. Contact water has been in contact with TLM or impacted sediments or appears to be visually impacted (e.g., contains large amounts of suspended solids, exhibits a sheen, or has TLM particles suspended within the water column). The area of origin of the water will be a primary consideration in determining which mode of water management will be used, along with a visual evaluation by site personnel.

Figure 3 presents a typical water management scenario for the routine handling of non-contact leakage water from the cofferdam and contact water from within the removal area (either at active work areas or other areas where visual impacts are observed). Other non-contact water will be either diverted to or managed similar to the cofferdam leakage water system. Figure 4 presents conceptual leakage control

details and typical outlet structure details. The outlet structure will be located at the downriver end of each cofferdam and used to lower the water surface inside the cofferdam to the river level during initial dewatering or following overtopping events. The following sections provide additional information on the planned water management activities.

Non-Contact Water From Initial Dewatering

Initial removal area water will be the river water left inside the isolated area following completion of the cofferdam construction. This water may also be left behind following an overtopping event, where the river levels temporarily exceed the height of the cofferdam and result in a flood of the previously dewatered area. This water will be considered “non-contact” as it will not have been in direct contact with impacted sediment and will be visually unimpacted. Currently two methods are planned for removing the initial water from the removal areas. These include the use of an outlet structure and/or pumps. The outlet structure will consist of a pipe installed as part of the cofferdam that will permit gravity flow of river water from inside the cofferdam to the outside river, while preventing backflow into the dewatered area with a check valve. The outlet structure will be located on the downstream end of the cofferdam.

The outlet structure will be the primary method for dewatering if initial water levels are elevated and following overtopping events. It will be supplemented with pumps stationed on the cofferdam or the adjacent riverbank that will be utilized to further dewater the area and permit access to the sediment. These pumps will also be used to remove the additional few feet of water located below the outlet structure intake but above the water column that is in contact with the impacted sediment. Project personnel will visually monitor the initial removal area water prior to and during discharge activities to ensure that it is free of sheens or excess turbidity. Downstream real-time total suspended solids (TSS) monitoring will be conducted during completion of riverside construction activities to ensure that the project does not contribute to elevated TSS levels within the river.

The time required for initial dewatering or dewatering following overtopping events will be a function of the river level outside the cofferdam and the pumping rate from inside the cofferdam to the river. For reference, at a river elevation of 116 feet (NGVD 29) and pumping rate of 1,000 gallons per minute (gpm), Areas 1 and 2 would require approximately 67 hours and 24 hours, respectively.

Non-Contact Leakage Water

Leakage or seepage water will result from the anticipated continuous movement of river water from outside of the cofferdam into the dewatered area. Water is expected to constantly move through and under the constructed cofferdam. Cofferdam leakage was previously estimated for a non-reinforced cofferdam (RIZZO, March 2013) at 0.37 to 1.42 gpm per foot (best estimate to upper bound estimate). For Area 1, this equates to approximately 450 gpm to an upper bound of 1,725 gpm. For Area 2, this equates to approximately 200 gpm to an upper bound of 785 gpm.

The leakage water is expected to be similar to the initial dewatering water in that it will be considered “non-contact” as it will not have been in direct contact with impacted sediment and will be visually unimpacted and sediment free. In order to collect the seepage water, a concrete berm, sandbag dike or other structure will be constructed roughly parallel to the interior toe of the cofferdam slope, as shown on Figure 3. This berm (detail provided on Figure 4) will be located in an unimpacted or previously excavated area and will be used to direct the leakage water to collection points where it will be pumped back over the structure. Management of the leakage water will likely be an around-the-clock activity and

redundant pumps will likely be present to provide a safeguard against mechanical failures or routine maintenance. The leakage water collection points will be visually monitored by project personnel for evidence of impacts such as sheens or the presence of sediment. If impacts are observed in the leakage water, changes will be made to eliminate the cause of the impacts.

The number of leakage water collection points will be based on the volume of water to be managed, sediment removal operations, and the overall topography of the dewatered removal area. The final design of the leakage water collection system will be determined by remediation personnel and will depend on field conditions, bedrock elevations and topography, etc.

Non-Contact Landside Stormwater Run-On

The project area includes the planned construction of the landside support zone as well as activities within the river. Since the landside support zone is currently undeveloped and vegetated, no stormwater inlets or conveyances are currently present and no increase in stormwater discharges to the municipal storm sewer from current conditions are anticipated during completion of the landside construction and operation activities. Figure 2 provides the currently anticipated landside support zone scenario. The major components will be placed and constructed in such a manner as to minimize clearing and grading activities. The primary planned location for the majority of site operations is the power line right-of-way, which has already been cleared of large vegetation. DESC has relocated the overhead wires from within the right-of-way to accommodate the landside operations. This scenario will reduce disturbance of currently forested land and further preserve the riparian corridor.

The stormwater associated with the landside operations will include precipitation and runoff from non-impacted areas. This stormwater will be controlled to prevent erosion and potential run-on of landside stormwater into the removal areas will be diverted and minimized to the extent practical. As currently planned, impacted sediment conditioning will be conducted within a temporary structure, which will minimize the potential for stormwater to contact the impacted sediment. Contact water generated at the landside operations, including stormwater if necessary, will be transferred to the water management system.

Newly cleared and graded areas such as site roads and material storage and lay down areas will be stabilized by the addition of geotextile material and gravel. Some minimal grading in the form of drainage swales, berms or other measures may be employed to direct stormwater runoff from the landside area away from the removal areas. Specific details pertaining to the management of stormwater and the planned erosion and sediment control measures will be addressed in the Comprehensive Stormwater Pollution Prevention Plan (C-SWPPP) to be submitted to the City of Columbia as part of the Notice of Intent for coverage under the South Carolina National Pollutant Discharge Elimination System (NPDES) General Permit for Stormwater Discharges from Construction Activities. Landside stormwater management activities will be conducted in accordance with the NPDES Permit and C-SWPPP. A draft Stormwater Management and Sediment Control Plan, which is a component of the C-SWPPP and provides the planned stormwater management and erosion and sediment control measures, is included with the Joint application submittal as Attachment K.

To minimize run-on into the removal areas, stormwater runoff from the landside operations area will be diverted toward surface areas with higher infiltration capacities to the extent practical. Diversion features (e.g., berms, sandbags, etc.) will be utilized to control flows as necessary. A conservative estimate of

potential run-on into the removal areas has been developed for planning purposes. Run-on resulting from an annual design storm event is estimated at approximately 241,000 gallons for Area 1 and 97,000 gallons for Area 2. These volumes are expected to be mitigated through diversion and infiltration measures, although the pumping capacities available within the removal areas to handle non-contact water management will be sufficient, if needed.

Non-Contact Removal Area Water

After initial dewatering, non-contact water within the removal areas is expected to be present in addition to cofferdam leakage and potential landside run-on. This water primarily includes residual water and potential upflow following initial dewatering and accumulations from precipitation events. Diversion features within the removal areas (berms, sandbags, etc.) will be utilized as needed to segregate non-contact water from contact water. This water will be collected and pumped to the river, either in conjunction with or in a manner similar to the leakage water expected along the inboard cofferdam toe.

The water will be visually monitored at collection points by project personnel for evidence of impacts such as sheens or the presence of sediment. If impacts are observed, changes will be made to eliminate the cause of the impacts. Other than residual amounts remaining after initial dewatering of the area, the majority of this non-contact water within the cofferdams is expected to accumulate from precipitation events. For planning purposes, the volume of precipitation resulting from an annual design storm event is estimated at approximately 186,000 gallons for Area 1 and 45,000 gallons for Area 2. The pumping capacities available to handle non-contact water will be sufficient to manage precipitation within the removal areas.

Contact Water

The onsite water management system will be used to contain, filter and discharge contact water. Contact water is expected to include:

- Entrained water that seeps from the sediment once it is excavated or disturbed in active removal areas;
- Precipitation that contacts the exposed impacted sediment; and
- Residual water following dewatering and accumulations from precipitation events within areas that exhibit impacts prior to impacted sediment removal.

Contact water will be collected and pumped to the water management system located in the landside support zone where it will be managed for disposal via discharge to the City of Columbia publicly owned treatment works (POTW) under an approved industrial wastewater discharge permit. A similar permit was obtained for the previously completed Huger Street MGP removal action and DESC is familiar with the City of Columbia permit and discharge requirements. The planned discharge location is a sanitary sewer manhole located near the eastern perimeter of the landside support zone shown on Figure 3. In some instances, as a contingency measure, the contact water may be transferred to tanker trucks and disposed of off-site at an approved treatment and disposal facility.

Following receipt of the POTW approval, the water will be managed and discharged in accordance with the permit requirements. The water management system's primary role is to collect and filter (i.e., remove solids from) the water that comes into contact with the impacted sediment. It will be sized

accordingly to minimize the potential for excavation downtime due to dewatering requirements. The system will be operated as required to maintain an acceptable discharge rate to the City of Columbia POTW sewer system. The components of the water management system will most likely consist of water storage tanks (e.g., 20,000 gallon frac tanks and/or larger volume modular tanks), filtration equipment such as bag filters and/or activated carbon vessels, associated piping and hoses and a totalizing flow meter. The storage tanks will provide flow equalization and provide residence time to allow for settling of solids. The final design for the water management system will be submitted to the City of Columbia for review as part of the industrial discharge permit request. For illustrative purposes, the general water storage tank and filtration/discharge scenario is provided on Figure 3. The total gallons discharged from the site will be tracked and sampling and analysis of the discharge water will be conducted as required by the POTW permit.

Excavation operations will likely begin at the highest point within the dewatered area and progress toward the lower lying areas. Water that has contacted impacted material will be directed to the lower lying unexcavated areas and pumped to the on-site water management system located in the landside support zone. Current excavation plans include temporarily staging extremely wet sediment within the confines of the open excavation and allowing the entrained water to drain out and collect in a low area where it will be pumped to the water management system. This technique will reduce the amount of material conditioning required to transport the impacted sediment to the disposal facility and the amount of water released from the sediment once it is transported to the landside support zone. Any contact water collected on the landside will also be transferred to the water management system.

The volume of contact water to be pumped and subsequently managed will be minimized to the extent possible by limiting the amount of open excavation area available for contact with precipitation, by proactively controlling leakage water, and by directing landside stormwater runoff away from open excavation areas.

ATTACHMENT A

FIGURES

- Figure 1 Site Location Map
- Figure 2 Conceptual Site Operations Plan
- Figure 3 Water Management Scenario
- Figure 4 Conceptual Leakage Control and Outlet Structure Details

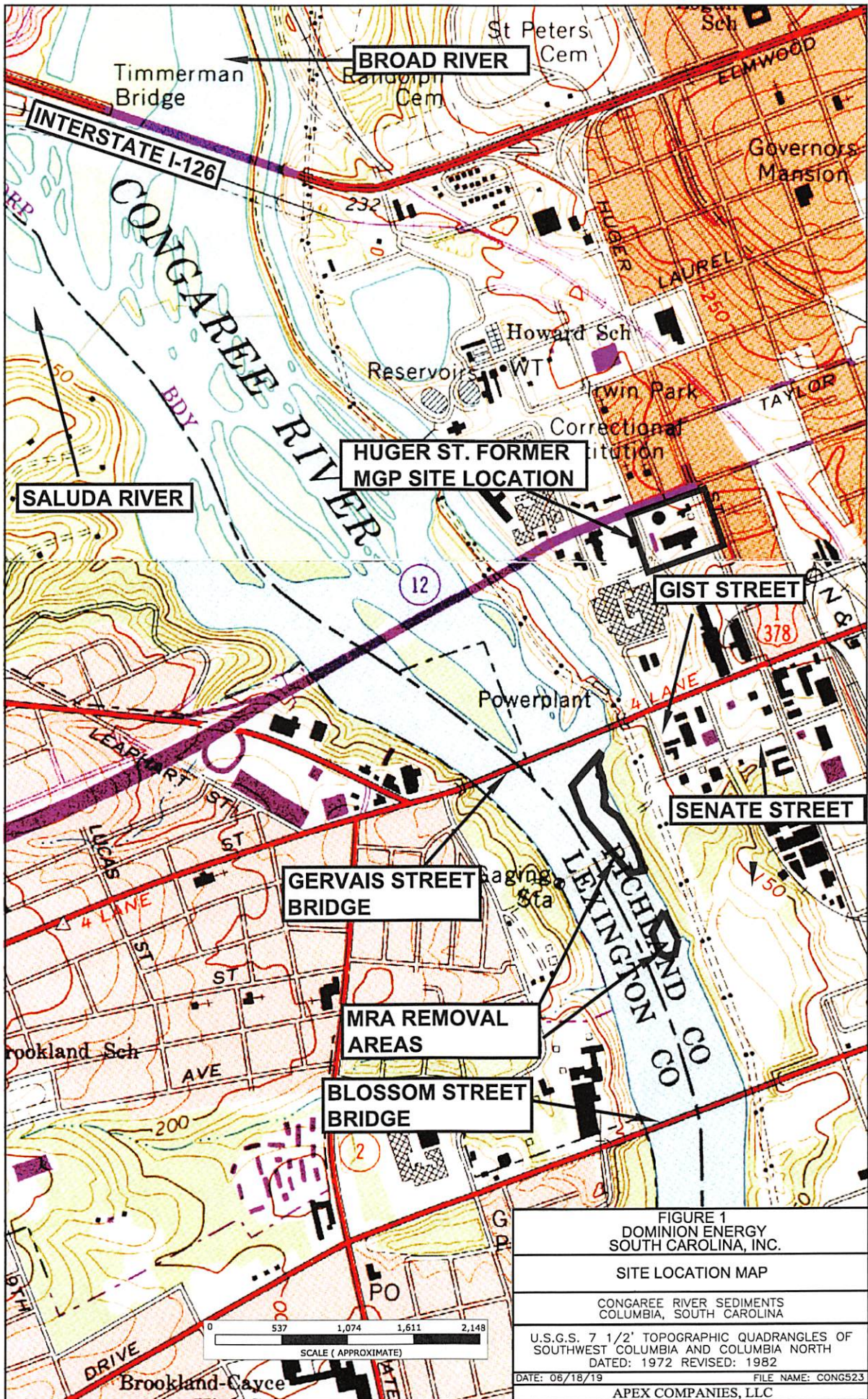

FIGURE 1
DOMINION ENERGY
SOUTH CAROLINA, INC.

SITE LOCATION MAP

CONGAREE RIVER SEDIMENTS
COLUMBIA, SOUTH CAROLINA

U.S.G.S. 7 1/2' TOPOGRAPHIC QUADRANGLES OF
SOUTHWEST COLUMBIA AND COLUMBIA NORTH
DATED: 1972 REVISED: 1982

DATE: 06/18/19

FILE NAME: CONG523

APEX COMPANIES, LLC

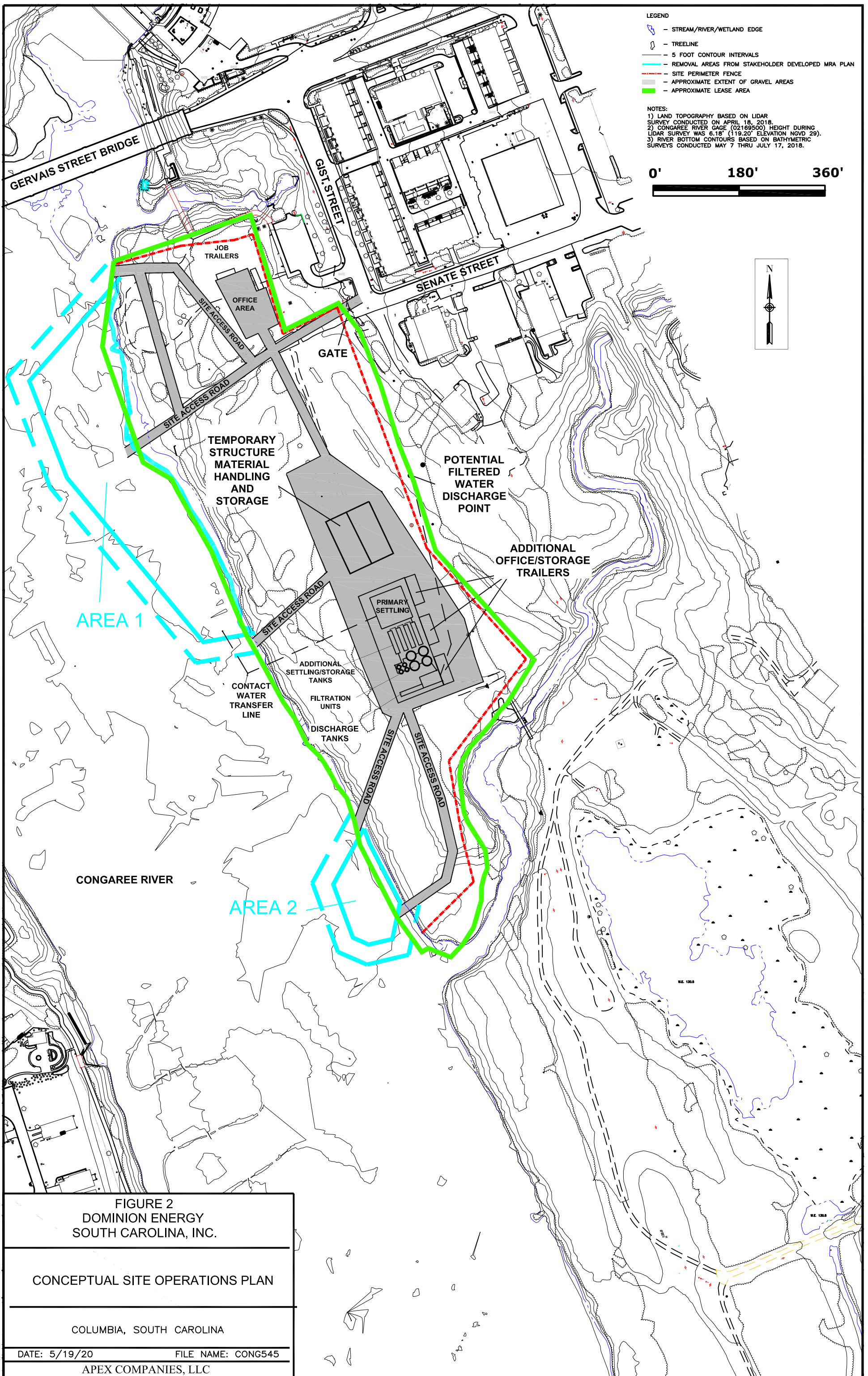

FIGURE 2
DOMINION ENERGY
SOUTH CAROLINA, INC.

CONCEPTUAL SITE OPERATIONS PLAN

COLUMBIA, SOUTH CAROLINA

DATE: 5/19/20

FILE NAME: CONG545

APEX COMPANIES, LLC

LEGEND

- GRAVEL AREA
- CONTACT WATER MANAGEMENT COMPONENT
- LEAKAGE WATER MANAGEMENT COMPONENT

- 1) ACTUAL LOCATIONS OF COLLECTION AND DISCHARGE POINTS WILL BE DETERMINED IN THE FIELD DURING IMPLEMENTATION.
- 2) SEDIMENT WILL BE REMOVED FROM THE LEAKAGE CONTROL DRAINAGE AND COLLECTION AREAS PRIOR TO CONSTRUCTION OF THE CURB.
- 3) LEAKAGE CONTROL WATER WILL BE VISUALLY INSPECTED PRIOR TO DISCHARGE.
- 4) IMPACTED WATER WILL BE TRANSFERRED TO WATER MANAGEMENT SYSTEMS TO DISCHARGE TO THE SANITARY SEWER SYSTEM.
- 5) OUTLET STRUCTURE WILL BE UTILIZED FOR INITIAL DISCHARGE OF WATER FOLLOWING COFFERDAM CONSTRUCTION OR OVERTOPPING EVENT.

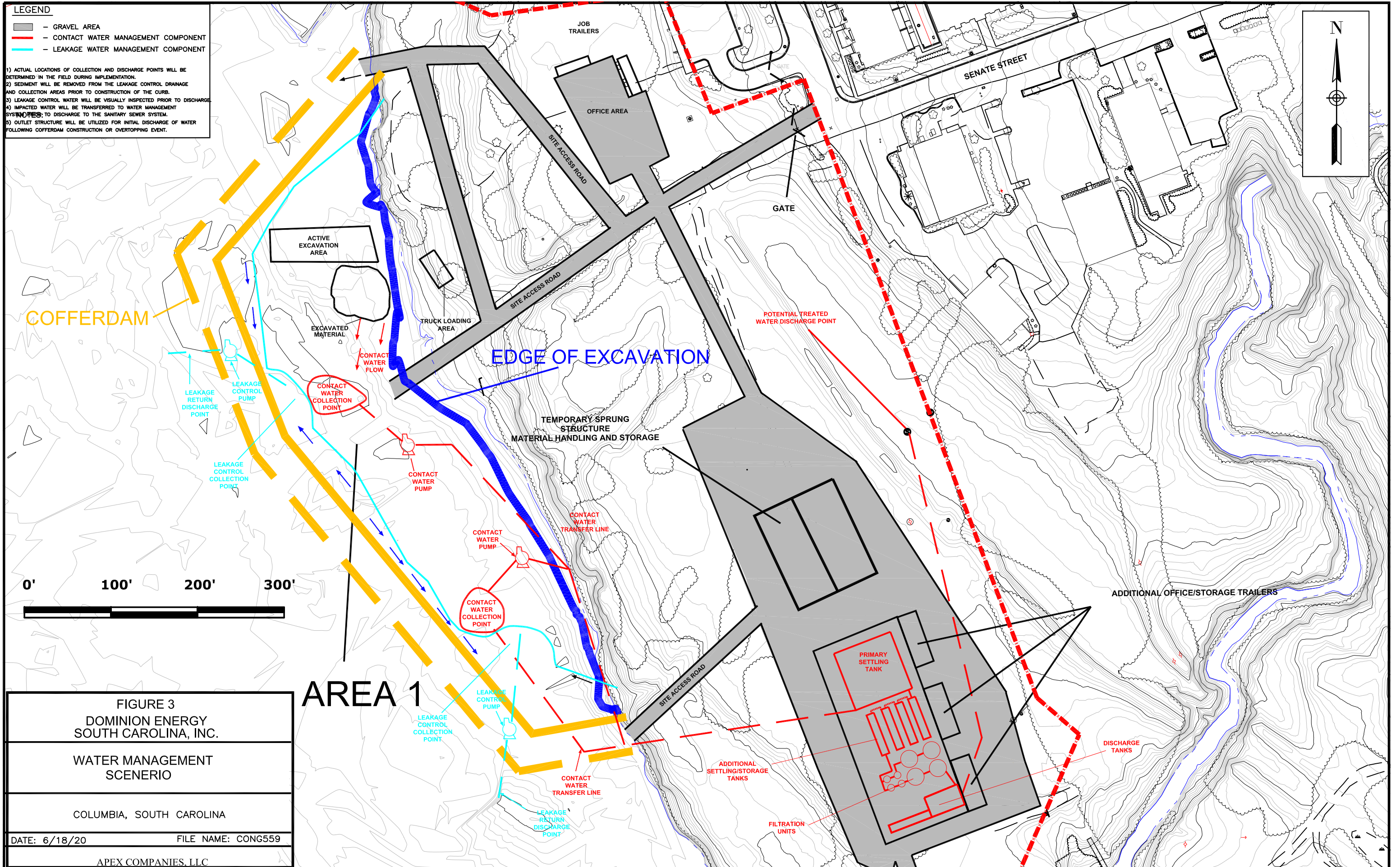
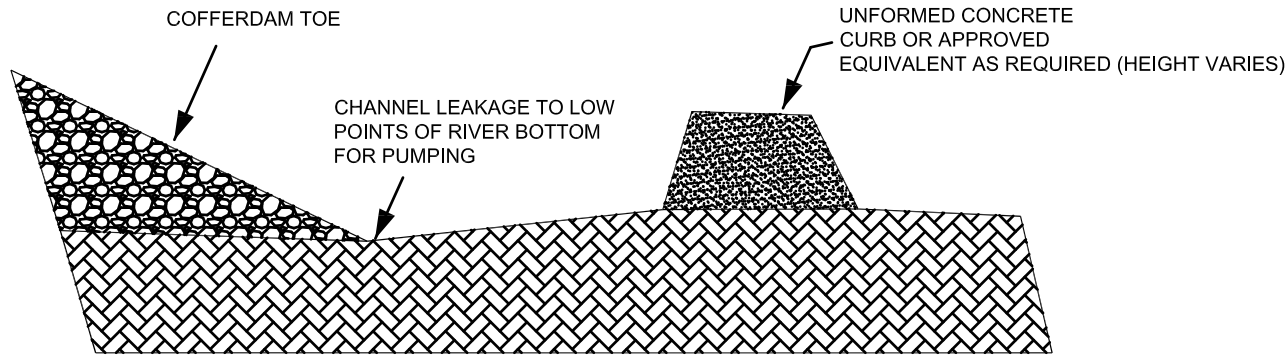
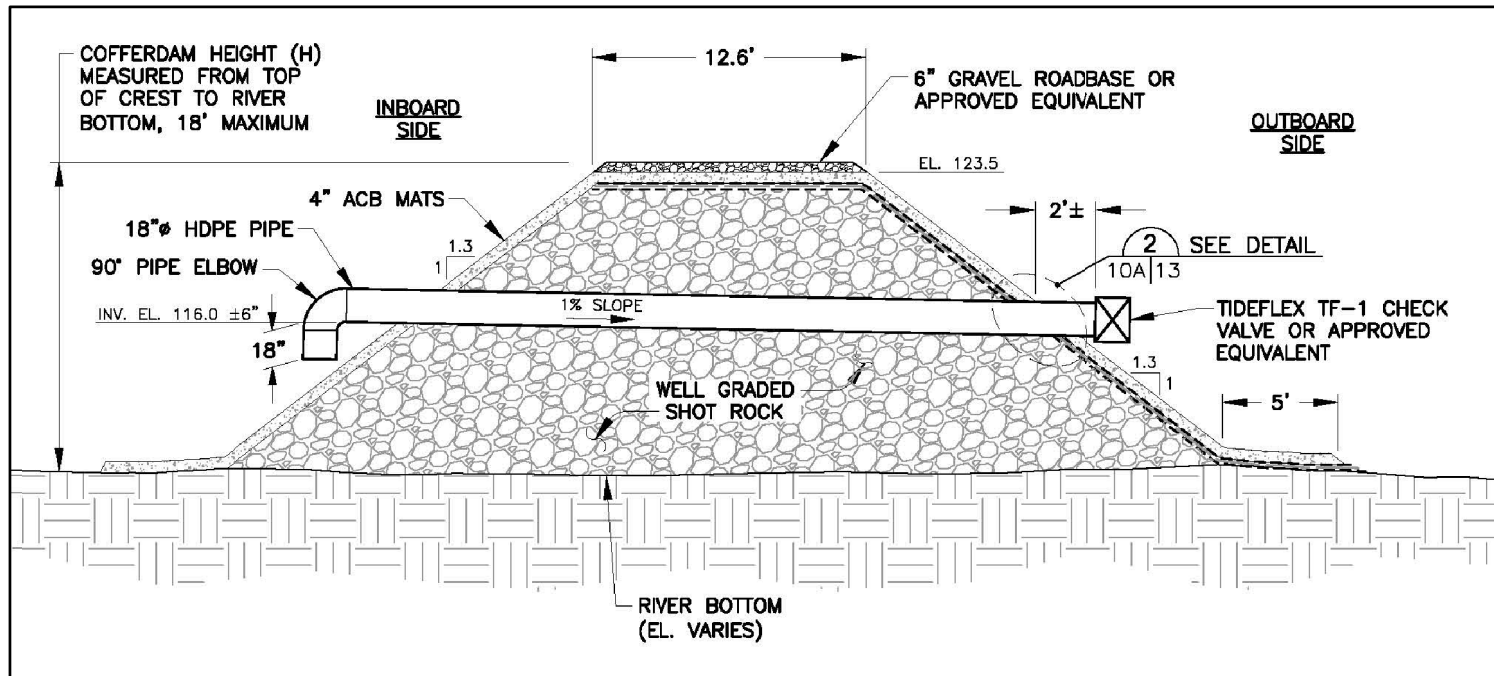

FIGURE 3
DOMINION ENERGY
SOUTH CAROLINA, INC.
WATER MANAGEMENT
SCENERIO
COLUMBIA, SOUTH CAROLINA
DATE: 6/18/20 FILE NAME: CONG559
APEX COMPANIES, LLC



LEAKAGE CONTROL



TYPICAL OUTLET STRUCTURE

FIGURE 4	
DOMINION ENERGY SOUTH CAROLINA, INC.	
CONCEPTUAL LEAKAGE CONTROL AND OUTLET STRUCTURE DETAILS	
COLUMBIA, SOUTH CAROLINA	
DATE: 8/3/20	FILE NAME: CONG573
APEX COMPANIES, LLC	

APPENDIX E

TOTAL SUSPENDED SOLIDS MONITORING PLAN



**TOTAL SUSPENDED SOLIDS (TSS)
MONITORING PLAN**

**CONGAREE RIVER MODIFIED REMOVAL ACTION
COLUMBIA, SOUTH CAROLINA**

September 2020

Prepared for:

Dominion Energy South Carolina, Inc.
400 Otarre Parkway
Cayce, SC 29033

Prepared by:

Apex Companies, LLC
1600 Commerce Circle
Trafford, PA 15085

**TOTAL SUSPENDED SOLIDS (TSS)
MONITORING PLAN**

**CONGAREE RIVER MODIFIED REMOVAL ACTION
COLUMBIA, SOUTH CAROLINA**

INTRODUCTION

Dominion Energy South Carolina, Inc. (DESC), formerly South Carolina Electric and Gas Company (SCE&G) plans to complete a Modified Removal Action (MRA) to address the occurrence of a tar-like material (TLM) that is commingled with sediment along the eastern shoreline of the Congaree River, just south of the Gervais Street Bridge in Columbia, South Carolina. The project area location is shown on Figure 1. The TLM is believed to be a coal tar material that originated from the Huger Street former manufactured gas plant (MGP) site located approximately 1,000 feet to the northeast of the project area (Figure 1). The proposed work is being performed by DESC at the direction of South Carolina Department of Health and Environmental Control (SCDHEC) and is subject to permits and approvals from the U.S. Army Corps of Engineers (USACE) and other agencies.

The overall objective of this project is to remove impacted sediment from the Congaree River within two areas. The current plan is to construct temporary cofferdams around each area to facilitate removal of the impacted sediment. As currently envisioned, the temporary cofferdams will be constructed sequentially and the MRA will occur over several years. The construction and active remediation season will occur from approximately May through October of each year. Figure 2 illustrates the proposed cofferdam locations. After each cofferdam is constructed, the isolated area will be dewatered, and the impacted sediment removed and transported off-site for disposal. Following completion of the removal activities in Area 1, the cofferdam will be removed, and a cofferdam will be constructed around Area 2. After the removal activities are completed in Area 2, the cofferdam materials will be removed from the river.

Construction activities are designed to be conducted with the intent of limiting and/or controlling the amount of sediment generated during the project. The cofferdam structure will contain any sediment released during sediment removal activities within the structure. The construction and removal of the cofferdam is anticipated to generate suspended solids that will be mostly attributable to the cofferdam material and not the existing river sediment. The amount of suspended solids within the project area will be monitored and mitigated through the implementation of this Plan. Areas of liberated sediment or construction materials (i.e., rock dust and/or fine particles from the shotrock used to construct the cofferdam) will be mainly located directly downstream of the cofferdam structure and impacts will be temporary. Primary sediment controls will involve deployment of a floating silt curtain and/or large sand bags to act as a barrier to downstream movement of sediment, adjacent to the active cofferdam construction area. Also, a critical element of this Plan is incorporation of a mixing zone approach. The mixing zone will provide a designated area for the short-term effects from constructing the cofferdam to subside as described further below.

TSS MONITORING PLAN OBJECTIVE

The objective of this Total Suspended Solids (TSS) Monitoring Plan is to ensure that the cofferdam construction and MRA operations do not directly cause the addition of significant or uncontrolled amounts of suspended solids within the Congaree River. Implementation of this Plan will provide a means to measure, collect and document real-time TSS information and compare the results to conservative action levels, as described herein. This Plan also establishes the appropriate contingency measures to be implemented in the event that elevated readings are observed during construction activities within the river.

TSS MONITORING PLAN CONTENTS

DESC plans to conduct TSS monitoring during operations that have the potential to generate or liberate sediment within the river, primarily during construction or removal of the cofferdam structures. Project-related TSS increases will result from:

- Placement or removal of cofferdam material on the river bottom which may liberate sediments;
- Placement or removal of cofferdam material as the cofferdam is built to design height or removed, which may release rock dust or small rock particles from shotrock material; and
- Disturbance of the shoreline during cofferdam tie-in construction and removal operations.

The planned locations of the cofferdams are shown on Figure 2. No TLM constituents of concern were identified in the riverbank soil. The cofferdam material (shotrock) will be from an off-site, borrow source and will be free of contamination. However, the cofferdam will be constructed around areas where deposits of TLM are known to exist, and the release of impacted sediment as well as particles from the cofferdam material during construction will pose a potential for migration of suspended solids downriver. The cofferdam will serve as a containment structure for work inside the structure. Implementation of this Plan will minimize the potential for increased TSS within the river due to cofferdam construction activities.

After the cofferdam is fully constructed and the only intrusive work is occurring within the isolated area, DESC may discontinue TSS monitoring. In the unlikely event that unplanned activities will pose a potential to liberate sediment, DESC will re-initiate monitoring activities, as required.

The TSS Monitoring Plan consists of the following:

- Identification of TSS controls;
- Establishment of “bench mark” level;
- Establishment of a mixing zone;
- Description of real-time field measurements of TSS;
- Determination of action levels for TSS exceedances;
- TSS monitoring instrumentation;
- Measurement frequency;
- Contingency measures; and

- Reporting.

TSS CONTROLS - SILT CURTAIN AND/OR SAND BAG BERM

TSS controls will involve deployment of a floating silt curtain and/or large sand bags to act as a barrier to downstream movement of sediment. For example, a silt curtain will be deployed downstream of the active work area prior to any construction activities to mitigate downstream migration of sediment. A berm made of large sand bags may also be utilized instead of, or in addition to, the silt curtain depending on river conditions. The sand bag berm would be placed downstream of the active work area, perpendicular to the flow direction and serve the same function as the silt curtain, which is to contain released sediment within the general work area. It is envisioned that multiple silt curtains and/or a row of large sand bags will be deployed as construction of the Area 1 cofferdam progresses downriver as shown on Figure 3. Only 1 silt curtain or sand bag berm will be required downriver of the Area 2 cofferdam.

TSS “BENCH MARK” LEVEL FOR THE PROJECT AREA

Table 1 provides historical analytical results for TSS measured by SCDHEC from January 1999 to December 2000 at water quality monitoring stations CSB-001L and CSB-001R (located just south of the Blossom Street Bridge). These water quality monitoring locations are shown on Figure 2. This is the most recent TSS data available at the time of plan development.

The historical data was utilized to develop an average TSS concentration for that timeframe and will serve as an initial “bench mark” concentration level for the project. The Congaree River exhibits highly variable flow rates and corresponding TSS concentrations based on factors including: the large drainage basin; upstream precipitation events; and runoff from upstream sources for both the Broad River and the Saluda River. During the timeframe noted above, the TSS measurements ranged from 1.2 mg/L to 42 mg/L with an average concentration of 7.3 mg/L. This bench mark value may be adjusted during the project if regularly measured background readings or pre-project monitoring establishes a more recent set of data for comparison to data collected during the project.

Due to the variability of TSS levels, exceedance of the bench mark level (TSS > 7.3 mg/L) likely occurs on a regular basis. Therefore, DESC proposes to utilize this average concentration as the bench mark level that will trigger more frequent TSS monitoring activities at pre-defined locations within the project area, as discussed below.

In addition to the bench mark criterion, “background” TSS readings will also be collected and utilized to evaluate action levels and exceedances as discussed in the following paragraphs.

MIXING ZONE

Directly downstream of the silt curtain and/or sandbag berm used for TSS control will be a mixing zone where a limited amount of disturbed sediment and cofferdam rock dust will likely pass through the control measures and migrate downstream. The TSS controls will be maintained to prevent any significant releases, but due to the nature of the project area and the river flow, some minor sediment or construction material movement from the work area is expected. Therefore, two separate mixing zones of approximately 725 feet in length for Area 1 (one mid-way thru the cofferdam [northern Area 1] and one at

the southern end [southern Area 1]) and one approximately 700 feet in length for Area 2 will be established downstream of the active work zone. The mixing zone lengths are based on the average river width at Areas 1 and 2. TSS levels in the work zone and the mixing zone will be monitored but periodic elevated levels and spikes will be acceptable as long as the downstream monitoring location does not exceed the action level. Collection of data periodically at these locations will provide insight into the appropriate corrective measures should action levels be triggered at the downstream location. It is anticipated that suspended solids will settle out within the mixing zone during movement downriver with the current.

MEASUREMENT OF REAL-TIME TSS LEVELS

DESC plans to conduct real-time monitoring of TSS concentrations in the vicinity of the project area during construction activities that have the potential to liberate sediments. Figure 3 provides TSS monitoring scenarios during construction of the Area 1 and Area 2 cofferdams. Monitoring during construction of the northern portion of northern Area 1 is represented. Similar monitoring scenarios will be established for completion of southern Area 1, as necessary. Monitoring locations include background (upstream), active work zone, mixing zone and downstream locations.

It is anticipated that the downstream location will be utilized for comparison to the action level and will be evaluated first. If the TSS readings are less than the bench mark value, then no additional monitoring is required for that period. If the readings are greater than the bench mark value, additional measurements will be obtained as discussed in this Plan.

ACTION LEVELS FOR TSS EXCEEDANCES

The Congaree River exhibits highly variable flow rates and corresponding TSS concentrations based on a factors including; the large drainage basin, upstream precipitation events, runoff from upstream sources for both the Broad River and the Saluda River. Due to this variability, natural exceedances of the bench mark occur on a regular basis, as seen on Table 1. Generally, as the river elevation increases so does TSS due to these upstream effects. Therefore, the objective of this Plan is to determine when the increase in TSS levels are due to MRA activities that result in “action level” triggers. Subsequently, a “background” reading will be collected directly upstream of the project area when the initial bench mark level of 7.3 mg/L is exceeded. Background level measurements may not be collected if readings downstream of the work area are below 7.3 mg/L. This data will be critical in determining if an elevated TSS reading is due to project-related activities. Measurements of TSS in the work zone and mixing zone may also be helpful in determining the source of the elevated TSS concentrations at the downstream location. As a side note, when river levels are significantly elevated, and sediment loads are heavy, there will likely be no in-the-river construction activities due to adverse working conditions.

For the purposes of this project, DESC proposes that an “action level” or significant increase in TSS concentration is defined as a reading of 25% higher than the “background” monitoring results. In summary, upstream (background) data will be compared with downstream monitoring results, measured after the mixing zone. If downstream TSS concentrations are less than 1.25 times the upstream results, then work can proceed. If the downstream TSS levels are sustained at greater than 1.25 times the upstream background measurement, then work will cease (i.e., a Stop Work Order will be issued) and contingency measures will be employed.

If a significant increase is noted between comparison of the upstream (background) and downstream concentrations, then mitigation/control measures will be implemented as described below. Exceedance of the action level below the mixing zone must be a sustained reading for at least 15 minutes. Transient readings, or intermittent “spikes” will not constitute a Stop Work Order. Also, if an action level exceedance can be attributed to a non-project-related condition, or unusual, natural or man-made event, the exceedance will be recorded in the field notes and no contingency measures will be employed and work may continue.

The following scenarios are provided to illustrate the potential monitoring and mitigation activities.

Scenario 1 – Downstream Readings < 7.3 mg/L

If the downstream TSS monitoring activities produce results below the bench mark of 7.3 mg/L, work will continue as planned without mitigation measures. Continued real-time monitoring and visual observations of river conditions directly downstream of the active work zone and the mixing zone will continue to be conducted on a daily basis as the project progresses. Background monitoring will not be necessary.

Scenario 2 – Downstream > 7.3 mg/L but <1.25 X Background

Exceedance of the bench mark level will trigger background monitoring (upstream of the project area) for comparison to the downstream monitoring data. If the downstream TSS monitoring activities produce results above 7.3 mg/L, but below 1.25 times the background level, work will continue as planned without mitigation measures. Continued real-time monitoring and visual observations of river conditions directly downstream of the active work zone and the mixing zone will be conducted daily as the project progresses.

Scenario 3 – Downstream Readings > than 1.25 X Background

If the downstream TSS monitoring activities produce consistent (sustained for 15 minutes) results above 1.25 times the background (upstream of the work area) level, a Stop Work Order will be implemented, and mitigation/control measures will be employed, as described below. Downstream and background monitoring will continue, and mitigation measures will remain in place until TSS concentrations below the mixing zone are reduced to less than 1.25 times the background concentration or below 7.3 mg/L for a period of two hours.

TSS MONITORING INSTRUMENTATION

To fulfill the monitoring requirements and objectives, DESC currently anticipates utilizing a combination of instruments and techniques. Measurements will be obtained by either a hand-held instrument and/or remote monitoring equipment positioned in the river. If the river is readily accessible from the shoreline, site personnel may be able to wade into the shallow water and collect readings via a hand-held TSS meter. The data will be downloaded or manually recorded. If the water is too deep, site personnel may use a small boat or kayak to collect the data. As a third option, a wireless buoy system may be employed. Examples of the proposed monitoring instruments are described below, and additional information is provided in Attachment B.

Hand-Held Instrumentation

As currently planned, the Royce Model 711 portable Suspended Solids / Interface Level analyzer or similar hand-held instrument will be used to collect real-time measurements in the river. The instrument is a rugged and waterproof device that provides reliable operation in rivers, lakes and other aqueous environments. DESC has utilized this instrument to conduct TSS monitoring at previous sediment remediation projects. Readings will be periodically obtained by project oversight personnel by lowering the instrument's probe into the water column and recording the results in a field logbook or daily monitoring form.

Remote Buoy Mounted Instrumentation

Project personnel may utilize the buoy system when the hand-held instrument will not provide representative TSS information and/or the appropriate monitoring location is not readily accessible. The remote buoy will contain a portable monitoring instrument capable of conducting continuous TSS monitoring and transmitting the real-time data to shore where it can be viewed and compared to the applicable action level.

Currently DESC envisions utilizing the YSI EXO1 Sonde multiparameter portable instrument and the EXO Turbidity Sensor with TSS functionality. The EXO1 can continuously collect data and store it onboard the instrument, transfer it to a data collection platform (DCP), or relay it directly to a PC or EXO handheld device. Communication to the instrument is accomplished by using a field cable, Bluetooth® wireless connection, or a USB connection. Since the instrumentation will likely be staged or moored within the Congaree River and access may be limited or difficult, the Bluetooth® wireless connection will be the likely method for data transmission.

If the remote system is utilized, the data will be downloaded or collected on a periodic basis throughout the day by oversight personnel and compared to the action level. For both handheld and the remote system, an effort will be made to place the sensor at approximately the midpoint of the water column to obtain a representative sample.

The same instrumentation and techniques will be employed to conduct the background monitoring, if required. Handheld devices will likely be utilized, if possible, and the remote system will be installed if adequate and representative background TSS concentrations cannot be obtained using the handheld device.

MEASUREMENT FREQUENCY

Pre-construction readings will be taken to document river TSS levels prior to commencement of activities. After construction activities begin for the day, the TSS readings will be obtained at approximate two-hour intervals. Either handheld readings will be conducted by field personnel or the remote buoy will be deployed, and the data downloaded or checked on the two-hour intervals. Monitoring will continue at this frequency while work is being conducted and one final reading will be obtained after activities are completed for the day to document post-construction conditions. If the action level is exceeded at any point during the day, background monitoring will be initiated, and the results compared to determine if mitigation measures are required.

If the downstream readings are less than the 1.25 times background threshold, work will continue, and downstream monitoring frequencies will remain at the approximate two-hour frequency. If the 1.25 times background threshold is exceeded, the appropriate mitigation measures will be employed, and monitoring will be conducted on an hourly basis until work is completed for the day or the action levels are no longer exceeded.

CONTINGENCY MEASURES

After an exceedance of the action level has been observed and it can be readily attributed to project activities, the following contingency measures will be implemented:

- A Stop Work Order will be issued to the construction/remediation contractor;
- An immediate inspection of the silt curtain and/or sand bag berm will be performed, and repairs or replacement will be made as appropriate;
- If the exceedance can be attributed to a damaged or dislocated silt curtain and repairs or redeployment are completed to the satisfaction of on-site personnel (QA/QC, regulatory agency representatives, or others) – work can then continue;
- If required, a second silt curtain will be deployed (outside of the first) and work will continue; and
- If the action level exceedance persists after the above measures have been implemented, another Stop Work Order will be issued, and the situation will be re-evaluated by field personnel in conjunction with DESC and regulatory agency representatives to determine additional contingency measures.

REPORTING

Daily reports of TSS monitoring results will be maintained on-site. Sustained action level exceedances, should they occur, and any subsequently implemented contingency measures will be communicated to the appropriate SCDHEC representative.

ATTACHMENTS

A Tables and Figures

Table 1	TSS Concentrations at SCDHEC Water Quality Monitoring Stations
Figure 1	Project Area Location
Figure 2	Project Area and Location of SCDHEC Water Monitoring Stations CSB-001L and CSB-001R
Figure 3	TSS Monitoring Scenarios

B Proposed Monitoring Instruments Information

ATTACHMENT A

Table and Figures

- | | |
|----------|---|
| Table 1 | TSS Concentrations at SCDHEC Water Quality Monitoring Stations |
| Figure 1 | Project Area Location |
| Figure 2 | Project Area and Location of SCDHEC Water Monitoring Stations CSB-001L and CSB-001R |
| Figure 3 | TSS Monitoring Scenarios |

TABLE 1

**TSS CONCENTRATIONS IN MG/L AT
SCDHEC WATER QUALITY MONITORING STATIONS
LOCATED DOWNSTREAM OF THE BLOSSOM STREET BRIDGE
JANUARY 1999 THROUGH DECEMBER 2000**

**Congaree River Sediments
Columbia, South Carolina**

Date Sampled	Monitoring Station	
	CSB-001L	CSB-001R
01/05/99	NA ⁽¹⁾	28
02/10/99	5.4	8
03/10/99	3	4.6
04/07/99	NA	7.2
05/12/99	3.9	5.6
06/24/99	3.6	3.9
07/07/99	3.9	3.2
08/31/99	5.9	6.6
09/30/99	4.2	7.1
10/21/99	1.7	4.2
11/08/99	4.2	8.2
12/16/99	2	3.8
01/05/00	NA	5.2
02/09/00	3	5.1
03/29/00	6.6	3.1
04/12/00	2.7	4.3
05/16/00	3.1	4
06/15/00	42	5.8
07/19/00	2.8	2.8
08/10/00	2.1	1.5
09/20/00	4.2	4
10/25/00	1.2	1.8
11/15/00	3.2	14
12/13/00	39	39

Average of both stations (mg/L): 7.3

Note:

(1) NA - not analyzed

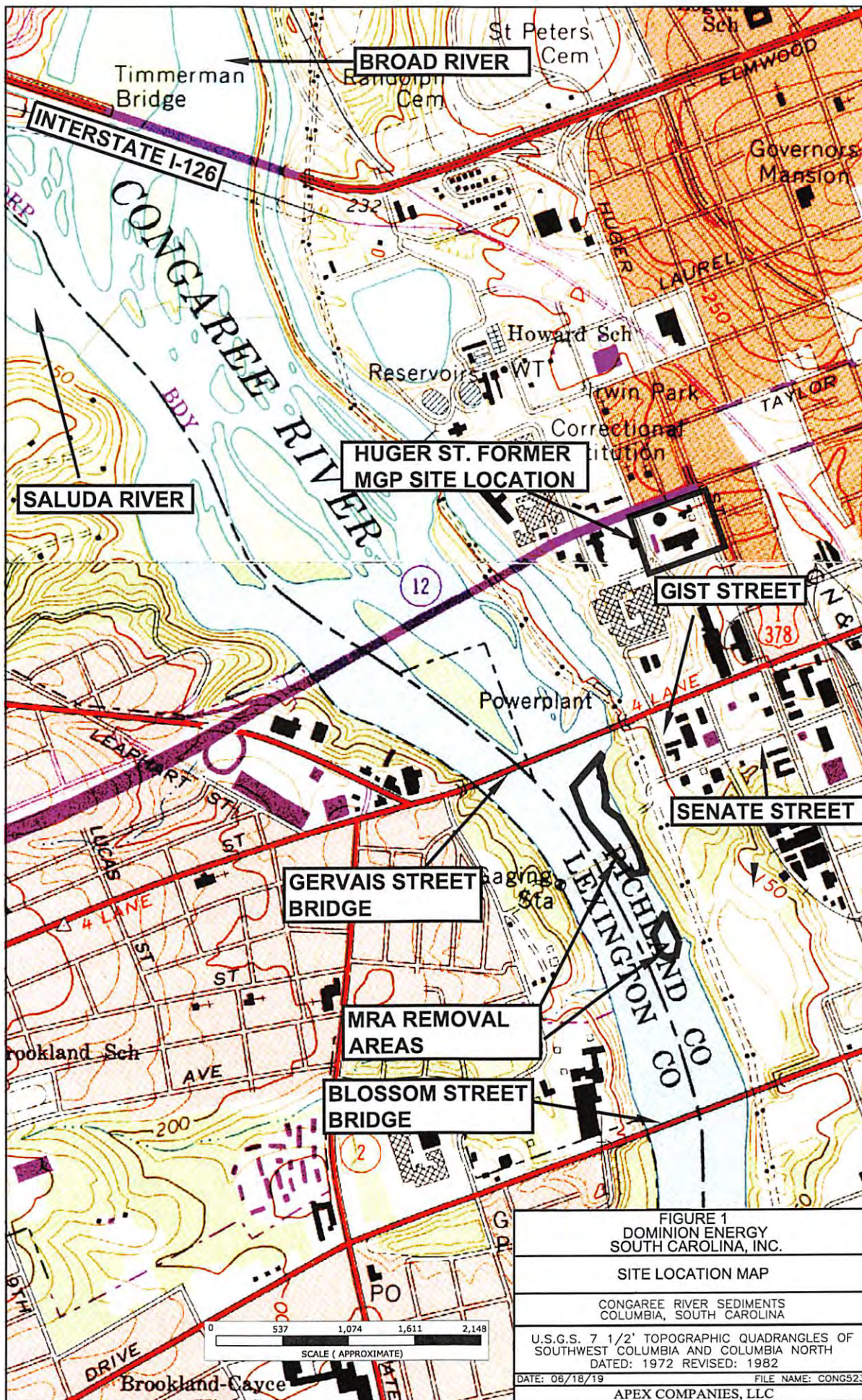

FIGURE 1
DOMINION ENERGY
SOUTH CAROLINA, INC.

SITE LOCATION MAP

CONGAREE RIVER SEDIMENTS
COLUMBIA, SOUTH CAROLINA

U.S.G.S. 7 1/2' TOPOGRAPHIC QUADRANGLES OF
SOUTHWEST COLUMBIA AND COLUMBIA NORTH
DATED: 1972 REVISED: 1982

DATE: 06/18/19 FILE NAME: CONGS23

APEX COMPANIES, LLC

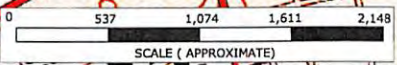



FIGURE 2

**DOMINION ENERGY
SOUTH CAROLINA, INC.**

**PROJECT AREA AND LOCATION OF SCDHEC WATER
MONITORING STATIONS CSB-001L AND CSB-001R**

**CONGAREE RIVER SEDIMENTS
COLUMBIA, SOUTH CAROLINA**

DATE: 5/8/2020 FILE NAME: CSB-001L

APEX COMPANIES, LLC

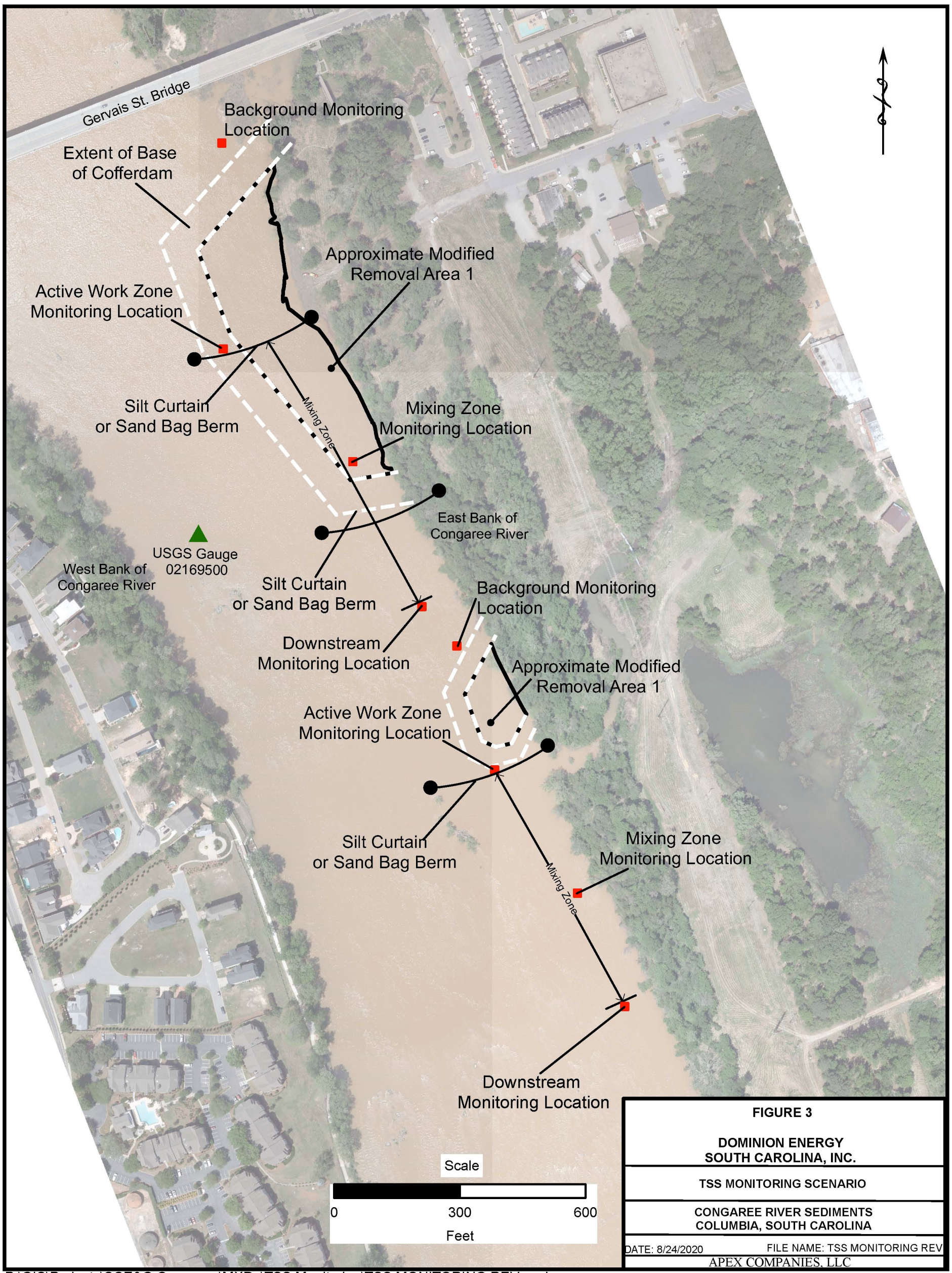

FIGURE 3

**DOMINION ENERGY
SOUTH CAROLINA, INC.**

TSS MONITORING SCENARIO

**CONGAREE RIVER SEDIMENTS
COLUMBIA, SOUTH CAROLINA**

DATE: 8/24/2020 FILE NAME: TSS MONITORING REV
APEX COMPANIES, LLC

ATTACHMENT B

Proposed Monitoring Instruments Information

Enhance Data Collection with these EXO Components

EXO Handheld

The EXO handheld provides an extremely durable, portable, weather-proof interface to the EXO sondes. The handheld uses a mobile version of the KOR interface software.

Additional standard features:

- GPS
- Temperature-compensated barometer
- Backlit alphanumeric keypad
- Microphone/speaker
- Wet-mate wireless connector
- Bluetooth communication
- Color LED screen
- 2 GB of storage
- Rechargeable battery capable



Interface with the EXO Sonde using the EXO Handheld Display

KOR Interface Software

The KOR Software offers users the capability to easily manage, visualize, and organize large amounts of field data. KOR also provides an interface to the EXO products for fast calibration, configuration, QA/QC or data collection.

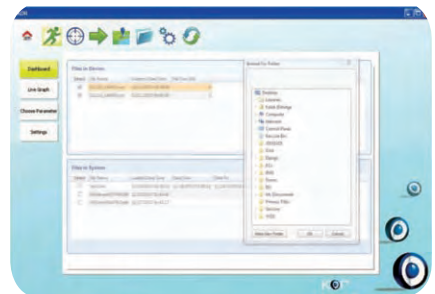

- New calibration processes for long-term monitoring
- Graphical user interface for quick data analysis
- Multiple languages

Multiple Data Output Options

Sonde output is readable by YSI handheld instruments, interface software, and data telemetry modules. In addition to the cable (standard), these communication interfaces are also available:

DCP Signal Output Adapter

Wires into the end of the YSI field cable via flying leads and converts signal to RS-232 or SDI-12 for datalogger applications.

USB Adapter

Allows connections between an EXO sonde and a PC.

Bluetooth Wireless Technology

Enables communication between a sonde and a user in the lab and pre-deployment in the field.



DCP Signal Output Adapter



USB Adapter



Sondes: EXO1 EXO2

Removable Bail

6-Pin Cable Connector

High-impact Xenoy Housing

Pressure Transducer Opening

Red LED Indicator - Status

Blue LED Indicator - Bluetooth

On/Off Magnetic Switch for Power and Bluetooth

4-Pin Wet-Mateable Connectors

Port Plug



Cable connector, battery valve, and expansion port for an additional sensor

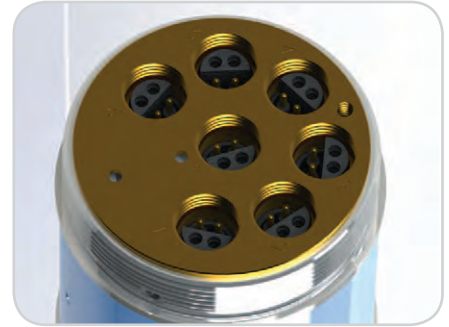

EXO2 sonde contains 6 universal sensor ports plus a central port for an anti-fouling wiper

Battery Compartment

Cutaway: Reinforced internal structure



Wiper keeps sensors clear of biofouling

Welded Titanium Housing



EXO1 sonde contains 4 universal sensor ports

Instrument Specifications*

EXO1 Sonde		
Ports	4 sensor ports Peripheral port: 1 power communication port	
Size	Diameter: 4.70 cm (1.85 in) Length: 64.77 cm (25.50 in)	
Weight	1.42 kg (3.15 lbs) with 4 probes, guard and batteries installed	
EXO2 Sonde		
Ports	7 sensor ports (6 ports available when central wiper used) Peripheral ports: 1 power communication port; 1 auxiliary expansion port	
Size	Diameter: 7.62 cm (3.00 in) Length: 71.10 cm (28.00 in)	
Weight	3.60 kg (7.90 lbs) with 5 probes, guard and batteries installed	
Sondes		
Operating Temperature	-5 to 50°C	
Storage Temperature	-20 to 80°C (except 0 to 60°C for pH and pH/ORP sensors)	
Depth Rating	0 to 250 m (0 to 820 ft)	
Communications	Computer Interface: Bluetooth wireless technology, RS-485, USB Output Options: USB with signal output adapter (SOA); RS-232 & SDI-12 with DCP-SOA	
Sample Rate	Up to 4 Hz	
Battery Life	90 days**	
Data Memory	512 MB total memory; >1,000,000 logged readings	
Sensors		Calculated Parameters
Ammonium**	ORP	Salinity
Chloride**	pH	Specific Conductance
Conductivity	Temperature	Total Dissolved Solids
Depth	Total Algae (Chlorophyll + BGA-PC or PE**)	Total Suspended Solids
Dissolved Oxygen	Turbidity	
Fluorescent Dissolved Organic Matter (fDOM)	Vented Level**	
Nitrate**		
EXO Handheld		
Size	Width: 12.00 cm (4.72 in) Height: 25.00 cm (9.84 in)	
Weight	0.71 kg (1.56 lbs) without batteries	
Operating System	Windows CE 5.0	
Operating Temperature	-10 to 50°C	
Storage Temperature	-20 to 80°C	
IP Rating	IP-67	
Data Memory	2 GB total memory; >2,000,000 data sets	
Accessories		
Cables (non-vented)	Flow cells	Sonde/sensor guard
Carrying case	KOR software	Calibration cup
DCP Signal Output Adapter	USB Signal Output Adapter	Anti-fouling components
Warranty		
1 Year	pH, ORP, and optical DO membranes	
2 Years	Cables, sondes (bulkheads), handheld, and the following sensors: conductivity, temperature, depth, and optical sensors	

* Specifications indicate typical performance and are subject to change. Please check EXOwater.com for up-to-date information.

** Typically 90 days at 20°C at 15-minute logging interval; temperature/conductivity, pH/ORP, DO, and turbidity sensors installed on EXO1; or temperature/conductivity, pH/ORP, DO, total algae, and turbidity sensors installed with central wiper that rotates once per logging interval on EXO2. Battery life is heavily dependent on sensor configuration.

EXO Bluetooth modules comply with Part 15C of FCC Rules and have FCC, CE Mark and C-tick approval. Bluetooth-type approvals and regulations can be country specific. Check local laws and regulations to insure that the use of wireless products purchased from Xylem are in full compliance.

** Release in 2013. BGA-PE specs TBD.

Sensor Specifications*

Sensor	Range	Accuracy*	Response	Resolution
Ammonium** ¹¹ (ammonia with pH sensor)	0 to 200 mg/L ¹	±10% of reading or 2 mg/L-N, w.i.g.	-	0.01 mg/L
Barometer	375 to 825 mmHg	±1.5 mmHg from 0 to 50°C	-	0.1 mmHg
Blue-green Algae Phycocyanin (PC) or Phycocerythrin (PE)** (part of Total Algae sensor)	0 to 100 µg/L PC; 0 to 100 RFU	Linearity: R ² > 0.999 for serial dilution of Rhodamine WT solution from 0 to 100 µg/mL PC equivalents Detection Limit: 0.04 µg/L PC	T63<2 sec	0.01 µg/L PC; 0.01 RFU
Chloride** ¹¹	0 to 1000 mg/L ²	±15% of reading or 5 mg/L, w.i.g.	-	0.01 mg/L
Chlorophyll (part of Total Algae sensor)	0 to 400 µg/L Chl; 0 to 100 RFU	Linearity: R ² > 0.999 for serial dilution of Rhodamine WT solution from 0 to 400 µg/L Chl equivalents Detection Limit: 0.09 µg/L Chl	T63<2 sec	0.01 µg/L Chl; 0.01 RFU
Conductivity ³	0 to 200 mS/cm	0 to 100: ±0.5% of reading or 0.001 mS/cm, w.i.g.; 100 to 200: ±1% of reading	T63<2 sec	0.0001 to 0.01 mS/cm (range dependent)
Depth ⁴ (non-vented)	0 to 10 m (0 to 33 ft)	±0.04% FS (±0.004 m or ±0.013 ft)	T63<2 sec	0.001 m (0.001 ft) (auto-ranging)
	0 to 100 m (0 to 328 ft)	±0.04% FS (±0.04 m or ±0.13 ft)		
	0 to 250 m (0 to 820 ft)	±0.04% FS (±0.10 m or ±0.33 ft)		
Vented Level**	0 to 10 m (0 to 33 ft)	±0.03% FS (±0.003 m or ±0.010 ft)		
Dissolved Oxygen Optical	0 to 500% air saturation	0 to 200%: ±1% of reading or 1% saturation, w.i.g.; 200 to 500%: ±5% of reading ⁵	T63<5 sec ⁶	0.1% air saturation
	0 to 50 mg/L	0 to 20 mg/L: ±0.1 mg/L or 1% of reading, w.i.g.; 20 to 50 mg/L: ±5% of reading ⁵		0.01 mg/L
fDOM	0 to 300 ppb Quinine Sulfate equivalents (QSE)	Linearity: R ² > 0.999 for serial dilution of 300 ppb QS solution Detection Limit: 0.07 ppb QSE	T63<2 sec	0.01 ppb QSE
Nitrate** ¹¹	0 to 200 mg/L-N ¹	±10% of reading or 2 mg/L-N, w.i.g.	-	0.01 mg/L
ORP	-999 to 999 mV	±20 mV in Redox standard solutions	T63<5 sec ⁷	0.1 mV
pH	0 to 14 units	±0.1 pH units within ±10°C of calibra- tion temp; ±0.2 pH units for entire temp range ⁸	T63<3 sec ⁹	0.01 units
Salinity (Calculated from Conductivity and Temperature)	0 to 70 ppt	±1.0% of reading or 0.1 ppt, w.i.g.	T63<2 sec	0.01 ppt
Specific Conductance (Calculated from Conductivity and Temperature)	0 to 200 mS/cm	±0.5% of reading or .001 mS/cm, w.i.g.	-	0.001, 0.01, 0.1 mS/cm (auto-scaling)
Temperature	-5 to 50°C	-5 to 35°C: ±0.01°C ¹⁰ 35 to 50°C: ±0.05°C ¹⁰	T63<1 sec	0.001 °C
Total Dissolved Solids (TDS) (Calculated from Conductivity and Temperature)	0 to 100,000 g/L Cal constant range 0.30 to 1.00 (0.64 default)	Not Specified	-	variable
Total Suspended Solids (TSS) (Calculated from Turbidity and TDS)	0 to 1500 mg/L	Not Specified	T63<2 sec	variable
Turbidity ¹¹	0 to 4000 FNU	0 to 999 FNU: 0.3 FNU or ±2% of reading, w.i.g.; 1000 to 4000 FNU: ±5% of reading ¹²	T63<2 sec	0 to 999 FNU: 0.01 FNU; 1000 to 4000 FNU: 0.1 FNU

All sensors have a depth rating to 250 m (820 ft), except shallow and medium depth sensors and ISEs. EXO sensors are not backward compatible with 6-Series sondes.

* Specifications indicate typical performance and are subject to change. Please check EXOwater.com for up-to-date information. Accuracy specification is attained immediately following calibration under controlled and stable environmental conditions. Performance in the natural environment may vary from quoted specification.

¹ 0-30°C ² 0-40°C w.i.g. = whichever is greater

³ Outputs of specific conductance (conductivity corrected to 25°C) and total dissolved solids are also provided. The values are automatically calculated from conductivity according to algorithms found in *Standard Methods for the Examination of Water and Wastewater* (Ed. 1989).

⁴ Accuracy specifications apply to conductivity levels of 0 to 100,000 µS/cm.

⁵ Relative to calibration gases

⁶ When transferred from air-saturated water to stirred deaerated water

⁷ When transferred from water-saturated air to Zobell solution

⁸ Within the environmental pH range of pH 4 to pH 10

⁹ On transfer from water-saturated air to rapidly stirred air-saturated water at a specific conductance of 800 µS/cm at 20°C; T63<5 seconds on transfer from water-saturated air to slowly-stirred air-saturated water.

¹⁰ Temperature accuracy traceable to NIST standards

¹¹ Calibration: 1-, 2-, or 3-point, user-selectable

¹² Specification is defined in AMCO-AEPA Standards

** Release in 2013. BGA-PE specs TBD.

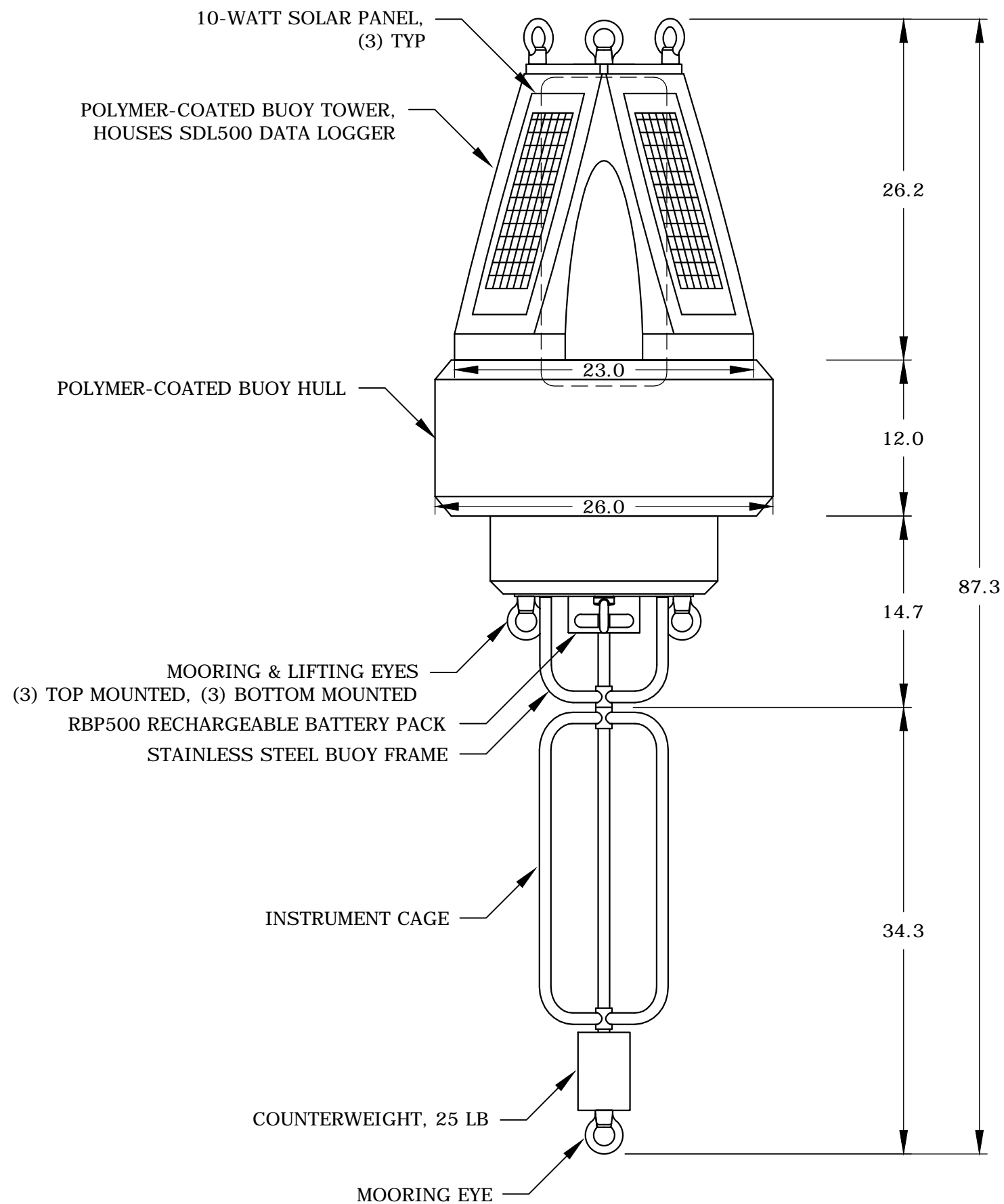

CB-200 DATA BUOY DIMENSIONAL VIEW

SCALE: 1:10

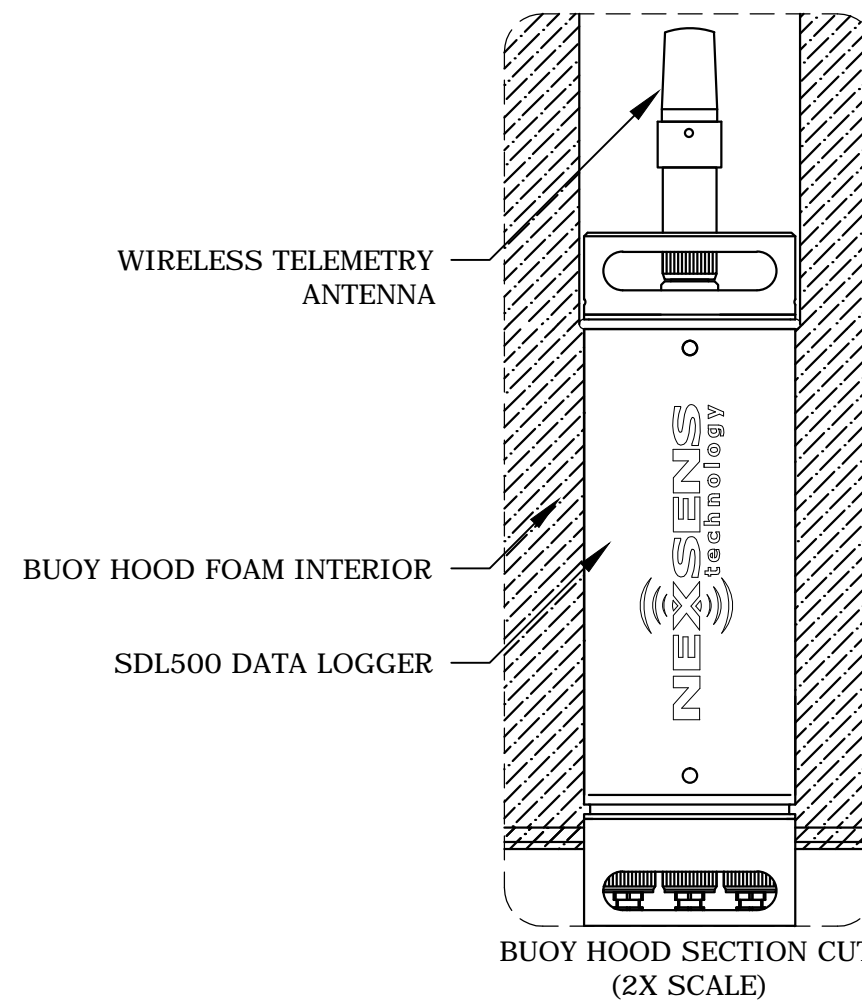

ITEM: NEXSENS CB-200 COASTAL DATA BUOY	DRAWN BY: MHD	SHEET: 1 of 1
	DATE: 8/6/13	
SHEET TITLE: DATA BUOY DIMENSIONAL VIEW	REV: 01	This drawing and the information thereon is the property of NexSens Technology All unauthorized use and reproduction is prohibited. < www.NexSens.com >
DRAWING NUMBER: NEX177		

Model 711 Portable Suspended Solids and Interface Level Analyzer



The Royce **Model 711** Portable Suspended Solids/ Interface Level Analyzer is a rugged, waterproof instrument designed for the rigors of remote sampling. The meter provides reliable operation in waste treatment plants, rivers, lakes and other aqueous systems. The meter will read in either grams per liter when in the suspended solids mode or relative density percentage while in the interface level mode of operation.

The **Model 711** stores the calibration values for suspended solids and interface level in two separate non-volatile memory locations allowing the user to switch between operational modes without having to recalibrate. The net effect is two analyzers in one.

Model 711 Specific Features

- ◆ **Two analyzers in one package:**
Switch from Solids measurement to Interface level without losing calibration.
- ◆ **Automatic ranging:**
Goes completely over the operating range of the analyzer with manual adjustment.
- ◆ **Simple, insitu calibration:**

Due to the full utilization of the microprocessor, calibration values are stored so that recalibration is not required on a daily basis. If the sensor is cleaned after use, monthly calibration is usually more than sufficient for proper operation in either mode of calibration.

The **Model 711** analyzer utilizes the **Model 71** medium range sensor. The **Model 71** is a rugged, reliable sensing element that has polymer optical grade lenses. It was designed specifically to meet the rigorous demands that are a requirement for a portable sensor.

Model 711 / 71 Specifications

Range:

0 - 10 grams per liter (0 to 10,000 mg/l)

Readout Device:

Harsh environment, 1/2" LCD digital display

Input Power:

Standard 9V battery

Enclosure:

Waterproof

Size:

7 inches long
3.2 inches wide
1.5 inches deep

Weight:

1.5 pounds (.68 kgms)

Type:

Single Gap, Optical

Accuracy: $\pm 5\%$ of reading or ± 100 mg/l, whichever is greater

Repeatability:

$\pm 1\%$ of reading or ± 20 mg/l, whichever is greater

Range:

0 - 10 g/l

Operating Limits:

Temperature, 0 - 65° C
Pressure, 0 - 50 PSIG

Size:

4 inches long
2 inches diameter

Weight:

1 pound (.45 kgms)

Construction:

Polyurethane body
Optical grade polymer lenses

Supplied Standard with Model 711 System

- ◆ **Model 711** rugged Suspended Solids analyzer
- ◆ **Model 71** rugged SS sensor with 8 meters or 25 feet of cable and waterproof, military connector. Cable is scaled in one foot increments.
- ◆ Velcro "grip strap" which can convert to a handy belt holder.
- ◆ 9V battery.
- ◆ Detailed instruction manual.